

SHREE H. N. SHUKLA COLLEGE OF IT & MGMT.



(Affiliated to Saurashtra University & GTU)

2 - Vaishali Nagar
Nr. Amrapali Under Bridge
Raiya Road, Rajkot.
Ph.No-(0281)2440478

3 - Vaishali Nagar
Nr. Amrapali Under Bridge
Raiya Road, Rajkot.
Ph. No-(0281)2471645



Lt. Shree Chimanbhai Shukla

BCA & B.Sc.IT SEM-4 - UNIX

Shree H.N.Shukla College,
2, Vaishali Nagar,
Nr. Amrapali Under Bridge
Raiya Road, Rajkot.
Ph. (0281)2440478, 2472590



Shree H.N.Shukla College,
3, Vaishali Nagar,
Nr. Amrapali Under Bridge
Raiya Road, Rajkot.
Ph. (0281)2471645

SHREE H. N. SHUKLA COLLEGE OF IT & MGMT.



(Affiliated to Saurashtra University & GTU)

2 - Vaishali Nagar
Nr. Amrapali Under Bridge
Raiya Road, Rajkot.
Ph.No-(0281)2440478

3 - Vaishali Nagar
Nr. Amrapali Under Bridge
Raiya Road, Rajkot.
Ph. No-(0281)2471645

UNIT – 1 (Part-1)

Introduction, Process and Thread, Process Scheduling

Topic: 1 What is Operating System?

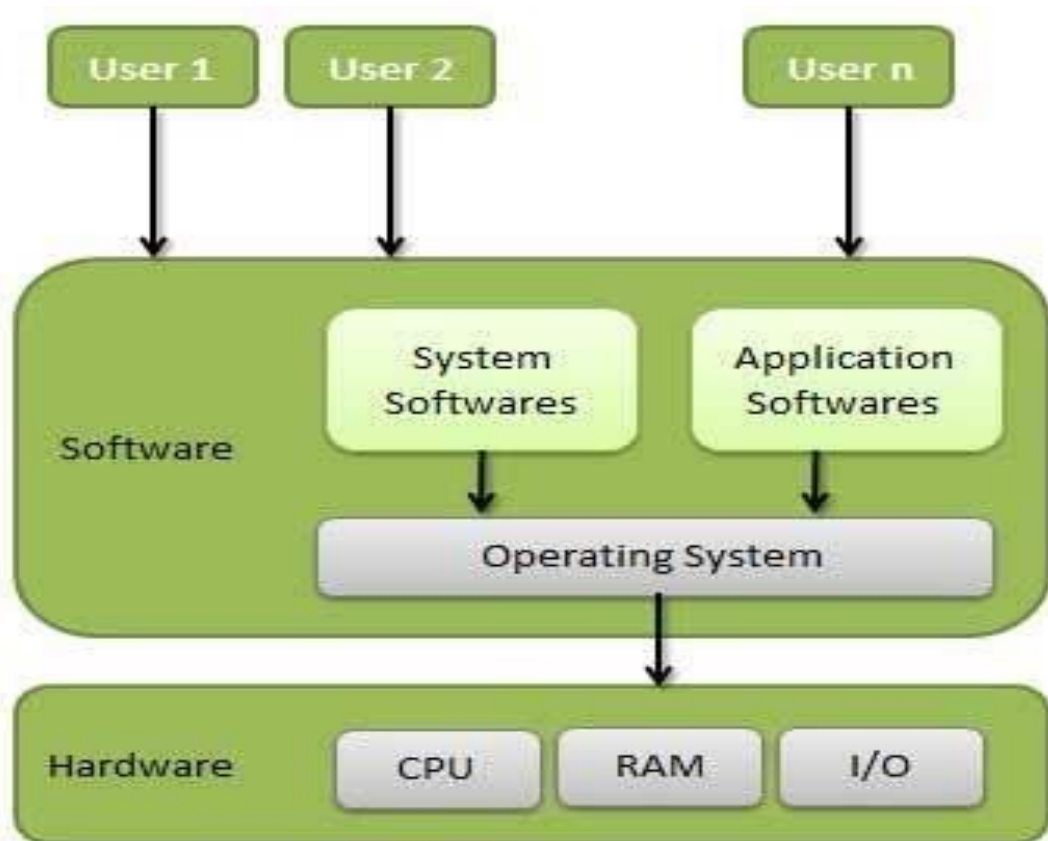

Detail:

- **Definition 1:**

An operating system (OS), in its most general sense, is software that allows a user to run other applications on a computing device.

SHREE H. N. SHUKLA COLLEGE OF IT & MGMT.



(Affiliated to Saurashtra University & GTU)

2 - Vaishali Nagar
Nr. Amrapali Under Bridge
Raiya Road, Rajkot.
Ph.No–(0281)2440478

3 - Vaishali Nagar
Nr. Amrapali Under Bridge
Raiya Road, Rajkot.
Ph. No–(0281)2471645

- **Definition 1:**

Operating system is an interface between user and hardware.

Operating system is a system application where user can run their applications and manage hardware on it.

One word question answer

Question	Answer
1. OS means?	Operating System
2. What is Operating System?	Interface between user and hardware

Topic: 2 Explain types of an operating system.

Ans.

Detail:

Here some types of an operating systems are:

- Batch Operating System
- Multitasking/Time Sharing OS
- Real Time OS
- Distributed OS
- Network OS

1. Batch Operating System

- Some computer processes are very lengthy and time-consuming. To speed the same process, a job with a similar type of needs is batched together and run as a group.
- The user of a batch operating system never directly interacts with the computer.
- In this type of OS, every user prepares his or her job on an offline device like a punch card and submit it to the computer operator.

SHREE H. N. SHUKLA COLLEGE OF IT & MGMT.



(Affiliated to Saurashtra University & GTU)

2 - Vaishali Nagar
Nr. Amrapali Under Bridge
Raiya Road, Rajkot.
Ph.No–(0281)2440478

3 - Vaishali Nagar
Nr. Amrapali Under Bridge
Raiya Road, Rajkot.
Ph. No–(0281)2471645

2. Multi-Tasking/Time-sharing Operating systems

- Time-sharing operating system enables people located at a different terminal(shell) to use a single computer system at the same time.
- The processor time (CPU) which is shared among multiple users is termed as time sharing.

3. Real time OS

- A real time operating system time interval to process and respond to inputs is very small.
- Examples: Military Software Systems, Space Software Systems.

4. Distributed Operating System

- Distributed systems use many processors located in different machines to provide very fast computation to its users.

5. Network Operating System

- Network Operating System runs on a server.
- It provides the capability to serve to manage data, user, groups, security, application, and other networking functions.

One word question answer

Question

Answer

- | | |
|--|-------------------------------|
| 1. Which operating system never directly interacts with the computer? | Batch operating system |
| 2. The processor time (CPU) which is shared among multiple users is known? | Time sharing operating system |
| 3. Which Operating System runs on a server? | Network operating system |

SHREE H. N. SHUKLA COLLEGE OF IT & MGMT.



(Affiliated to Saurashtra University & GTU)

2 - Vaishali Nagar
Nr. Amrapali Under Bridge
Raiya Road, Rajkot.
Ph.No–(0281)2440478

3 - Vaishali Nagar
Nr. Amrapali Under Bridge
Raiya Road, Rajkot.
Ph. No–(0281)2471645

Topic: 3 Explain features of an operating system.

Ans.

Detail:

Here is a list commonly found important features of an Operating System:

1. Security Management

- The information and confidential data stored in the system is protected by the operating system and block the system by giving strong authorized keys to the user securing the system from malware attack.
- The operating system acts as supervisor mode and gives the system a strongly protected firewall. OS handle and rectify the errors as soon as possible without any difficulty.

2. Process Management

- The program execution is managed effectively by the operating system without any overlapping or time delay.
- The management of the process supports OS to develop and eliminate process and provides mechanism form communication and synchronization within multiple processes.

3. Storage and Memory Management

- OS performs memory management and virtual memory multitasking.
- The need for memory management in OS is to allocate and de-allocate memory space to process in demand of resources or if they are running out of memory that leads to alerts called file system and disk space is high or full.
- The operating system can do resource allocation and prevent the system from overloading.

SHREE H. N. SHUKLA COLLEGE OF IT & MGMT.



(Affiliated to Saurashtra University & GTU)

2 - Vaishali Nagar
Nr. Amrapali Under Bridge
Raiya Road, Rajkot.
Ph.No–(0281)2440478

3 - Vaishali Nagar
Nr. Amrapali Under Bridge
Raiya Road, Rajkot.
Ph. No–(0281)2471645

4. Disk Management

- OS permits disk access to manage files systems, file system device drivers and related activities of files like retrieval, naming, sharing, storage and protection of files.

5. I/O Operations

- OS can effectively handle I/O operations to hide the odd behavior of hardware from the end-user.

6. Device Management

- The device and printer controlling are managed by an operating system by permitting a correct flow.
- Disk management is performed to track all hardware connected to the system and also the resource utilized by different jobs and users.

One word question answer

Question

Answer

- | | |
|--|-----------------|
| 1. The operating system acts as a _____. | supervisor mode |
| 2. Operating system can do process management. | True |
| 3. OS permits disk access to manage _____ | files systems. |
| 4. The operating system can do resource allocation and prevent the system from _____ | overloading |

SHREE H. N. SHUKLA COLLEGE OF IT & MGMT.



(Affiliated to Saurashtra University & GTU)

2 - Vaishali Nagar
Nr. Amrapali Under Bridge
Raiya Road, Rajkot.
Ph.No–(0281)2440478

3 - Vaishali Nagar
Nr. Amrapali Under Bridge
Raiya Road, Rajkot.
Ph. No–(0281)2471645

Topic: 4 Explain functions of an operating system.

Ans.

Detail:

Following are some of important functions of an operating System.

- I/O System Management
- Secondary-Storage Management
- Security
- Command interpretation
- Networking
- Job accounting
- Communication management

1. I/O System Management:

- One of the main objects of any OS is to hide the specialty of that hardware devices from the user.

2. Secondary-Storage Management:

- Systems have several levels of storage which includes primary storage, secondary storage, and cache storage.
- Instructions and data must be stored in primary storage or cache so that a running program can reference it.

3. Security:

- Security module protects the data and information of a computer system against malware threat and authorized access.

4. Command interpretation:

- This module is interpreting commands given by the and acting system resources to process that commands.



SHREE H. N. SHUKLA COLLEGE OF IT & MGMT.



(Affiliated to Saurashtra University & GTU)

2 - Vaishali Nagar
Nr. Amrapali Under Bridge
Raiya Road, Rajkot.
Ph.No–(0281)2440478

3 - Vaishali Nagar
Nr. Amrapali Under Bridge
Raiya Road, Rajkot.
Ph. No–(0281)2471645

5. Networking:

- A distributed system is a group of processors which do not share memory, hardware devices.
- The processors communicate with one another through the network.

6. Job accounting:

- Keeping track of time & resource used by various job and users.

7. Communication management:

- Coordination and assignment of compilers, interpreters, and another software resource of the various users of the computer systems.

One word question answer

Question

1. Instructions and data must be stored in _____.

Answer

primary storage or cache

2. The ___communicate with one another through the network. processors

Topic: 5 Explain operating system with user view and system view.

Ans.

Detail:

Operating System is designed both by taking user view and system view into consideration.

User View

- The goal of the Operating System is to maximize the work and minimize the effort of the user.

SHREE H. N. SHUKLA COLLEGE OF IT & MGMT.



(Affiliated to Saurashtra University & GTU)

2 - Vaishali Nagar
Nr. Amrapali Under Bridge
Raiya Road, Rajkot.
Ph.No–(0281)2440478

3 - Vaishali Nagar
Nr. Amrapali Under Bridge
Raiya Road, Rajkot.
Ph. No–(0281)2471645

- Most of the systems are designed to be operated by single user, however in some systems multiple users can share resources, memory. In these cases, Operating System is designed to handle available resources among multiple users and CPU efficiently.
- Operating System must be designed by taking both usability and efficient resource utilization into view.
- In embedded systems (Automated systems) user view is not present.
- Operating System gives an effect to the user as if the processor is dealing only with the current task, but in background processor is dealing with several processes.

System View

- From the system point of view Operating System is a program involved with the hardware.
- Operating System is allocator, which allocate memory, resources among various processes. It controls the sharing of resources among programs.
- It prevents improper usage, error, and handle deadlock conditions.
- It is a program that runs all the time in the system in the form of Kernel.
- It controls application programs that are not part of Kernel.

One word question answer

Question

Answer

1. The goal of the operating system is. maximize the work and minimize the effort of the user.
2. In which systems user view is not present. Embedded system

SHREE H. N. SHUKLA COLLEGE OF IT & MGMT.



(Affiliated to Saurashtra University & GTU)

2 - Vaishali Nagar
Nr. Amrapali Under Bridge
Raiya Road, Rajkot.
Ph.No–(0281)2440478

3 - Vaishali Nagar
Nr. Amrapali Under Bridge
Raiya Road, Rajkot.
Ph. No–(0281)2471645

UNIT – 1 (Part-2)

Topic: 1 What is process in operating system?

Ans.

Detail:

- A process is basically a program in execution. The execution of a process must progress in a sequential fashion.
- A process is defined as an entity which represents the basic unit of work to be implemented in the system.
- To put it in simple terms, we write our computer programs in a text file and when we execute this program, it becomes a process which performs all the tasks mentioned in the program.

One word question answer

Question

1. The process is _____
2. When we execute computer program, it becomes.

Answer

- a program in execution.
A process

SHREE H. N. SHUKLA COLLEGE OF IT & MGMT.



(Affiliated to Saurashtra University & GTU)

2 - Vaishali Nagar
Nr. Amrapali Under Bridge
Raiya Road, Rajkot.
Ph.No-(0281)2440478

3 - Vaishali Nagar
Nr. Amrapali Under Bridge
Raiya Road, Rajkot.
Ph. No-(0281)2471645

Topic: 2 Explain process life cycle and process state diagram.

Ans.

Process State Diagram

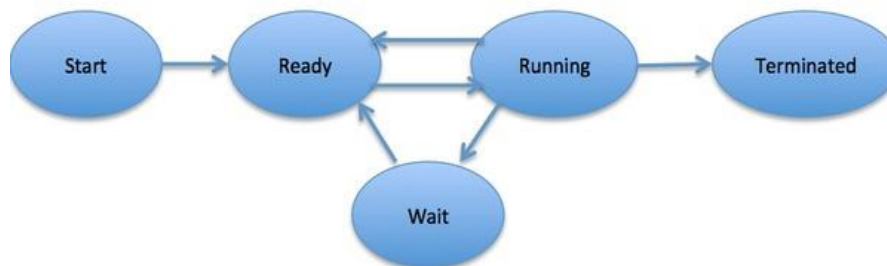

Process Life Cycle

- When a process executes, it passes through different states. These stages may differ in different operating systems, and the names of these states are also not standardized.
- In general, a process can have one of the following five states at a time.

1	START THIS IS THE INITIAL STATE WHEN A PROCESS IS FIRST STARTED/CREATED.
2	Ready The process is waiting to be assigned to a processor. Ready processes are waiting to have the processor allocated to them by the operating system so that they can run. Process may come into this state after Start state or while running it by but interrupted by the scheduler to assign CPU to some other process.
3	Running Once the process has been assigned to a processor by the OS scheduler, the process state is set to running and the processor executes its instructions.
4	Waiting Process moves into the waiting state if it needs to wait for a resource, such as waiting for user input, or waiting for a file to become available.
5	Terminated or Exit. Once the process finishes its execution, or it is terminated by the operating system, it is moved to the terminated state where it waits to be removed from main memory.

SHREE H. N. SHUKLA COLLEGE OF IT & MGMT.



(Affiliated to Saurashtra University & GTU)

2 - Vaishali Nagar
Nr. Amrapali Under Bridge
Raiya Road, Rajkot.
Ph.No-(0281)2440478

3 - Vaishali Nagar
Nr. Amrapali Under Bridge
Raiya Road, Rajkot.
Ph. No-(0281)2471645

One word question answer

Question

1. Which is the initial state when a process is first started.
2. Once the process finishes its execution its move on_____

Answer

start

exit state

Topic: 3 Explain process control block(PCB).

Process Control Block is a [data structure](#) that contains information of the process related to it. The process control block is also known as a task control block.

Structure of the Process Control Block

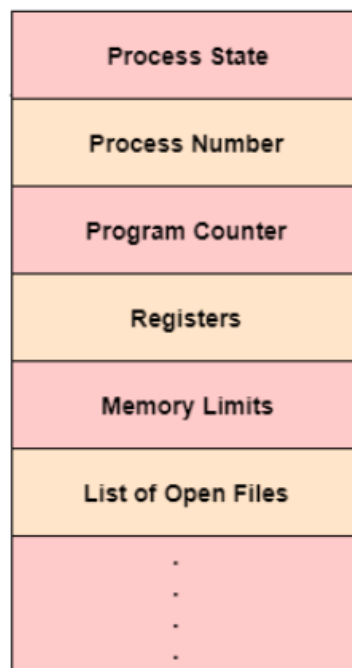

Process Control Block (PCB)

SHREE H. N. SHUKLA COLLEGE OF IT & MGMT.



(Affiliated to Saurashtra University & GTU)

2 - Vaishali Nagar
Nr. Amrapali Under Bridge
Raiya Road, Rajkot.
Ph.No–(0281)2440478

3 - Vaishali Nagar
Nr. Amrapali Under Bridge
Raiya Road, Rajkot.
Ph. No–(0281)2471645

The following are the data items –

Process State

This specifies the process state i.e. new, ready, running, waiting or terminated.

Process Number

This shows the number of the particular process.

Program Counter

This contains the address of the next instruction that needs to be executed in the process. The address of the following instruction to be executed from memory is stored in a CPU register called a program counter (PC) in the computer processor.

Registers

This specifies the registers that are used by the process. They may include accumulators, index registers, stack pointers, general purpose registers etc. Accumulators, index and general-purpose registers, and condition code information are all included in the CPU.

List of Open Files

These are the different files that are associated with the process

CPU Scheduling Information

The process priority, pointers to scheduling queues etc. is the CPU scheduling information that is contained in the PCB.

Memory Management Information

The memory management information includes the page tables or the segment tables depending on the memory system used.

SHREE H. N. SHUKLA COLLEGE OF IT & MGMT.



(Affiliated to Saurashtra University & GTU)

2 - Vaishali Nagar
Nr. Amrapali Under Bridge
Raiya Road, Rajkot.
Ph.No-(0281)2440478

3 - Vaishali Nagar
Nr. Amrapali Under Bridge
Raiya Road, Rajkot.
Ph. No-(0281)2471645

I/O Status Information

This information includes the list of [I/O devices](#) used by the process, the list of files etc.

Accounting information

The time limits, account numbers, amount of [CPU](#) used, process numbers etc. are all a part of the PCB accounting information.

Location of the Process Control Block

The process control block is kept in a memory area that is protected from the normal user access. This is done because it contains important process information. Some of the operating systems place the PCB at the beginning of the kernel stack for the process as it is a safe location.

Topic : 4 What is context switching?

A procedure known as context switching includes moving the CPU from one job or process to another. It is the technique of preserving a process's state such that it can be recovered and continued running at a later time. This is a crucial component of a multitasking operating system since it enables numerous processes to share a single CPU.

Therefore, anytime there is a context switch during code execution, the CPU registers temporarily store the current state of that process. Conserving time and avoiding the need to access the secondary memory, this aids in the process's quick execution (hard disk).

Topic :5 What is Thread?

Ans.

A thread is a flow of execution through the process code, with its own program counter that keeps track of which instruction to execute next, system registers which hold its current working variables, and a stack which contains the execution history.

A thread is also called a **lightweight process**.

SHREE H. N. SHUKLA COLLEGE OF IT & MGMT.



(Affiliated to Saurashtra University & GTU)

2 - Vaishali Nagar
Nr. Amrapali Under Bridge
Raiya Road, Rajkot.
Ph.No-(0281)2440478

3 - Vaishali Nagar
Nr. Amrapali Under Bridge
Raiya Road, Rajkot.
Ph. No-(0281)2471645

A thread shares with its peer threads few information like code segment, data segment and open files. When one thread alters a code segment memory item, all other threads see that.

The process can be split down into so many threads. **For example**, in a browser, many tabs can be viewed as threads. MS Word uses many threads - formatting text from one thread, processing input from another thread, etc.

Each thread belongs to exactly one process and no thread can exist outside a process. Each thread represents a separate flow of control. Threads have been successfully used in implementing network servers and web server.

The following figure shows the working of a single-threaded and a multithreaded process.

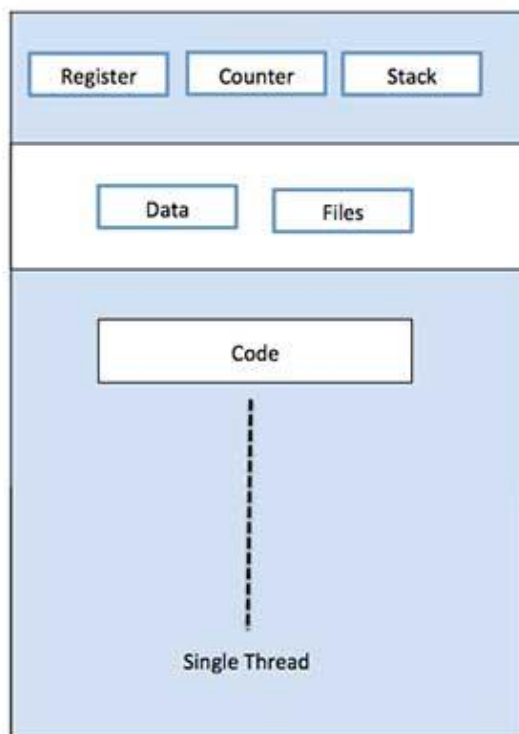

Single Process P with single thread

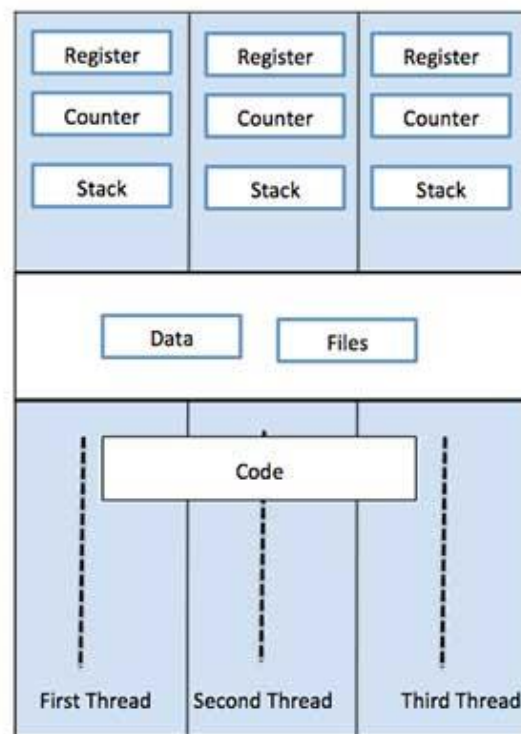

Single Process P with three threads

SHREE H. N. SHUKLA COLLEGE OF IT & MGMT.



(Affiliated to Saurashtra University & GTU)

2 - Vaishali Nagar
Nr. Amrapali Under Bridge
Raiya Road, Rajkot.
Ph.No–(0281)2440478

3 - Vaishali Nagar
Nr. Amrapali Under Bridge
Raiya Road, Rajkot.
Ph. No–(0281)2471645

Why Multi-Threading?

A thread is also known as a lightweight process. The idea is to achieve parallelism by dividing a process into multiple threads. For example, in a browser, multiple tabs can be different threads. MS Word uses multiple threads: one thread to format the text, another thread to process inputs, etc. More advantages of multithreading are discussed below.

Multithreading is a technique used in operating systems to improve the performance and responsiveness of computer systems. Multithreading allows multiple threads (i.e., lightweight processes) to share the same resources of a single process, such as the CPU, memory, and I/O devices.

Topic : 6 Benefits of Threads

Ans ;

- **Enhanced throughput of the system:** When the process is split into many threads, and each thread is treated as a job, the number of jobs done in the unit time increases. That is why the throughput of the system also increases.
- **Effective Utilization of Multiprocessor system:** When you have more than one thread in one process, you can schedule more than one thread in more than one processor.
- **Faster context switch:** The context switching period between threads is less than the process context switching. The process context switch means more overhead for the CPU.
- **Responsiveness:** When the process is split into several threads, and when a thread completes its execution, that process can be responded to as soon as possible.
- **Communication:** Multiple-thread communication is simple because the threads share the same address space, while in process, we adopt just a few exclusive communication strategies for communication between two processes.
- **Resource sharing:** Resources can be shared between all threads within a process, such as code, data, and files. Note: The stack and register cannot be shared between threads. There is a stack and register for each thread.

SHREE H. N. SHUKLA COLLEGE OF IT & MGMT.



(Affiliated to Saurashtra University & GTU)

2 - Vaishali Nagar
Nr. Amrapali Under Bridge
Raiya Road, Rajkot.
Ph.No-(0281)2440478

3 - Vaishali Nagar
Nr. Amrapali Under Bridge
Raiya Road, Rajkot.
Ph. No-(0281)2471645

Topic: 7 Types of Threads ?

Ans :

In the operating system, there are two types of threads.

1. User-level thread.
2. Kernel level thread.

1. User-level thread

The operating system does not recognize the user-level thread. User threads can be easily implemented and it is implemented by the user. If a user performs a user-level thread blocking operation, the whole process is blocked. The kernel level thread does not know nothing about the user level thread. The kernel-level thread manages user-level threads as if they are single-threaded processes?examples: Java thread, POSIX threads, etc.

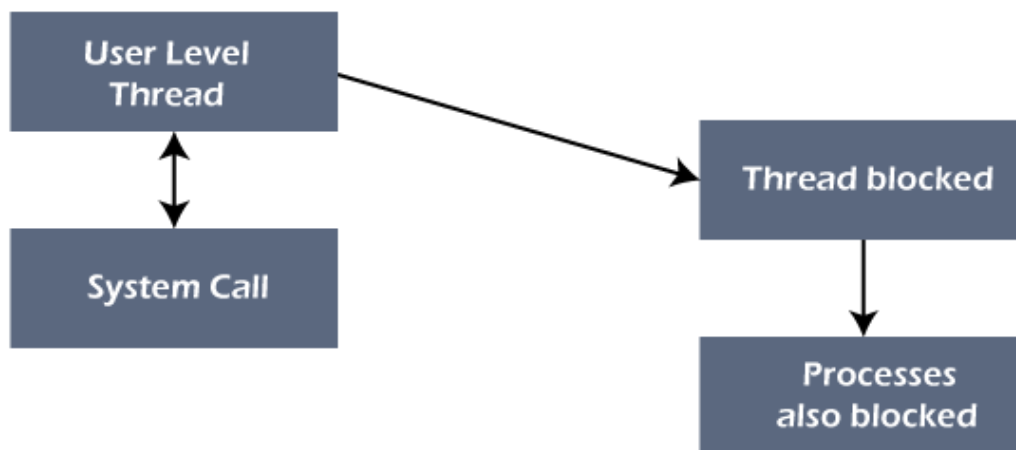

SHREE H. N. SHUKLA COLLEGE OF IT & MGMT.



(Affiliated to Saurashtra University & GTU)

2 - Vaishali Nagar
Nr. Amrapali Under Bridge
Raiya Road, Rajkot.
Ph.No–(0281)2440478

3 - Vaishali Nagar
Nr. Amrapali Under Bridge
Raiya Road, Rajkot.
Ph. No–(0281)2471645

2. Kernel level thread

The kernel thread recognizes the operating system. There is a thread control block and process control block in the system for each thread and process in the kernel-level thread. The kernel-level thread is implemented by the operating system. The kernel knows about all the threads and manages them. The kernel-level thread offers a system call to create and manage the threads from user-space. The implementation of kernel threads is more difficult than the user thread. Context switch time is longer in the kernel thread. If a kernel thread performs a blocking operation, the Banky thread execution can continue. Example: Window Solaris.

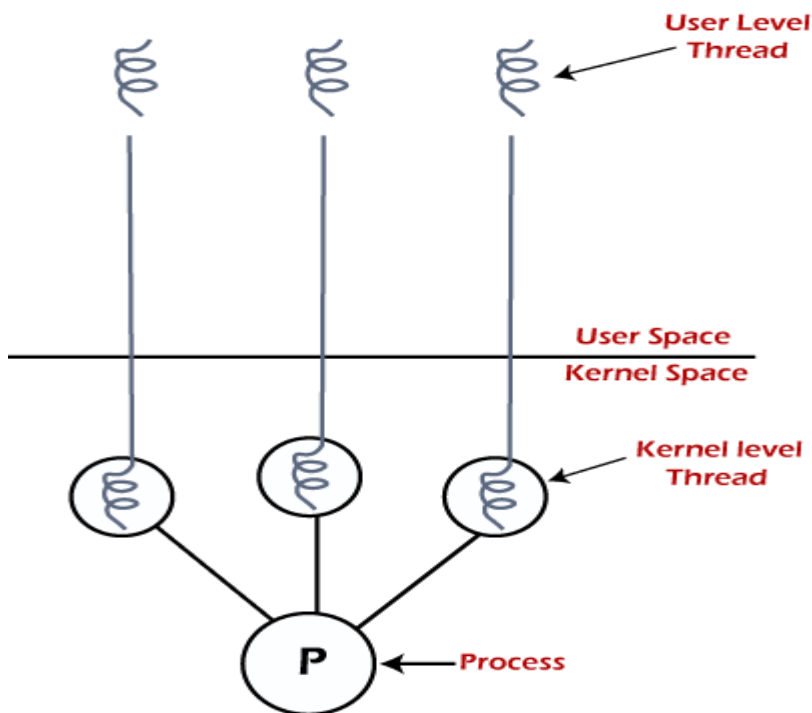

SHREE H. N. SHUKLA COLLEGE OF IT & MGMT.



(Affiliated to Saurashtra University & GTU)

2 - Vaishali Nagar
Nr. Amrapali Under Bridge
Raiya Road, Rajkot.
Ph.No–(0281)2440478

3 - Vaishali Nagar
Nr. Amrapali Under Bridge
Raiya Road, Rajkot.
Ph. No–(0281)2471645

UNIT – 1 (Part-3)

Topic: 1 What is process scheduling?

Ans.

Detail:

- The process scheduling is the activity of the process manager that handles the removal of the running process from the CPU and the selection of another process based on a particular strategy.
- Process scheduling is an essential part of a Multiprogramming operating systems.
- Such operating systems allow more than one process to be loaded into the executable memory at a time and the loaded process shares the CPU using time multiplexing.

One word question answer

Question

1. Process scheduling is an essential part of _____
2. The process scheduling is the activity of the _____

Answer

multiprogramming operating systems.
process manager.

Topic: 2 Explain types of process scheduling?

Ans.

Detail:

An operating system uses two types of scheduling processes execution, **preemptive** and **non-preemptive**.

1. Preemptive process:

- In preemptive scheduling policy, a low priority process must be suspended its execution if high priority process is waiting in the same queue for its execution.

SHREE H. N. SHUKLA COLLEGE OF IT & MGMT.



(Affiliated to Saurashtra University & GTU)

2 - Vaishali Nagar
Nr. Amrapali Under Bridge
Raiya Road, Rajkot.
Ph.No–(0281)2440478

3 - Vaishali Nagar
Nr. Amrapali Under Bridge
Raiya Road, Rajkot.
Ph. No–(0281)2471645

2. Non - Preemptive process:

- In non - preemptive scheduling policy, processes are executed in first come first serve basis, which means the next process is executed only when currently running process finishes its execution.

Operating system performs the task of scheduling processes based on priorities using these following algorithms:

1) First come first serve (FCFS)

In this scheduling algorithm the first process entered in queue is processed first.

2) Shortest job first (SJF)

In this scheduling algorithm the process which requires shortest CPU time to execute is processed first.

3) Priority scheduling

In this scheduling algorithm the priority is assigned to all the processes and the process with highest priority executed first. Priority assignment of processes is done based on internal factor such as CPU and memory requirements or external factor such as user's choice. The priority scheduling algorithm supports preemptive and non - preemptive scheduling policy.

4) Round Robin (RR) scheduling

In this algorithm the process is allocated the CPU for the specific time called time slice, which is normally of 10 to 100 milliseconds. If the process completes its execution within this time slice, then it is removed from the queue otherwise it must wait for another time slice.

SHREE H. N. SHUKLA COLLEGE OF IT & MGMT.



(Affiliated to Saurashtra University & GTU)

2 - Vaishali Nagar
Nr. Amrapali Under Bridge
Raiya Road, Rajkot.
Ph.No-(0281)2440478

3 - Vaishali Nagar
Nr. Amrapali Under Bridge
Raiya Road, Rajkot.
Ph. No-(0281)2471645

One word question answer

Question

1. In which process scheduling type processes are executed in first come first serve basis.
2. In which process scheduling the process with highest priority executed first.

Answer

Non - Preemptive process

Priority scheduling

Topic: 3 Explain First Come First Serve (FCFS) process scheduling algorithm.

Ans.

Detail:

- In the "First come first serve" scheduling algorithm, as the name suggests, the process which arrives first, gets executed first, or we can say that the process which requests the CPU first, gets the CPU allocated first.
- This is used in Batch Systems.
- A perfect real-life example of FCFS scheduling is buying tickets at ticket counter.

Example:

Suppose there are four processes with process ID's **P1**, **P2**, **P3**, and **P4** and they enter into the CPU as follows:

PROCESS ID	ARRIVAL TIME (MILLISECONDS)	BURST TIME (MILLISECONDS)
P1	0	5
P2	2	3
P3	6	2
P4	7	3

- **Step 1:**

Gant Chart:

SHREE H. N. SHUKLA COLLEGE OF IT & MGMT.



(Affiliated to Saurashtra University & GTU)

2 - Vaishali Nagar
Nr. Amrapali Under Bridge
Raiya Road, Rajkot.
Ph.No–(0281)2440478

3 - Vaishali Nagar
Nr. Amrapali Under Bridge
Raiya Road, Rajkot.
Ph. No–(0281)2471645

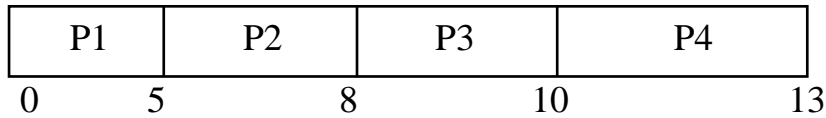

- **Step 2:**

Turn Around Time = Completion Time – Arrival Time

Waiting Time = Turn Around Time – Burst Time

P ID	Arrival Time	Burst Time	Completion time (milliseconds)	Turn Around Time (milliseconds)	Waiting Time (milliseconds)
P1	0	5	5	5	0
P2	2	3	8	6	3
P3	6	2	10	4	2
P4	7	3	13	6	3

- **Step 3:**

Avg. Turn Around Time = Total Turn Around Time/No. of Process

$$(5+6+4+6)/4 = 21/4 = 5.25 \text{ ms}$$

Avg. Waiting Time = Total Waiting Time/No. of Process

$$(0+3+2+3)/4 = 8/4 = 2 \text{ ms}$$

- **Step 4:**

Throughput = Total Burst Time/No. of Process

$$(5+3+2+3)/4 = 13/4 = 3.25 \text{ ms}$$

- **Step 5:**

CPU Utilization = Total Estimated Time/Total Estimated Time * 100

$$13/13 * 100 = 100\%$$

SHREE H. N. SHUKLA COLLEGE OF IT & MGMT.



(Affiliated to Saurashtra University & GTU)

2 - Vaishali Nagar
Nr. Amrapali Under Bridge
Raiya Road, Rajkot.
Ph.No–(0281)2440478

3 - Vaishali Nagar
Nr. Amrapali Under Bridge
Raiya Road, Rajkot.
Ph. No–(0281)2471645

One word question answer

Question

1. In which process scheduling type processes are executed in first come first serve basis.
2. Formula of turnaround time.
3. Formula of waiting time.

Answer

- FCFS
Completion Time – Arrival Time
Turn Around Time – Burst Time

Topic: 4 Explain Shortest Job First (SJF) process scheduling algorithm.

Ans.

Detail:

- Shortest job first is a scheduling algorithm in which the process with the smallest execution time is selected for execution next.
- Shortest job first can be either preemptive or non-preemptive.

Example:

Suppose there are four processes with process ID's **P1**, **P2**, **P3**, and **P4** and they enter the CPU as follows:

PROCESS ID	ARRIVAL TIME (MILLISECONDS)	BURST TIME (MILLISECONDS)
P1	0	5
P2	2	3
P3	3	2
P4	1	3

SHREE H. N. SHUKLA COLLEGE OF IT & MGMT.



(Affiliated to Saurashtra University & GTU)

2 - Vaishali Nagar
Nr. Amrapali Under Bridge
Raiya Road, Rajkot.
Ph.No-(0281)2440478

3 - Vaishali Nagar
Nr. Amrapali Under Bridge
Raiya Road, Rajkot.
Ph. No-(0281)2471645

- **Step 1:**

Gant Chart:

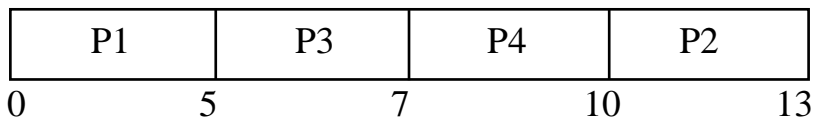

- **Step 2:**

Turn Around Time = Completion Time – Arrival Time

Waiting Time = Turn Around Time – Burst Time

PID	ARRIVAL TIME	BURST TIME	COMPLETION TIME	TURN AROUND TIME	WAITING TIME
P1	0	5	5	5	0
P2	2	3	7	5	2
P3	3	2	10	7	5
P4	1	3	13	12	9

- **Step 3:**

Avg. Turn Around Time = Total Turn Around Time/No. of Process

$$(5+5+7+12)/4 = 29/4 = 7.25 \text{ ms}$$

Avg. Waiting Time = Total Waiting Time/No. of Process

$$(0+2+5+9)/4 = 16/4 = 4 \text{ ms}$$

SHREE H. N. SHUKLA COLLEGE OF IT & MGMT.



(Affiliated to Saurashtra University & GTU)

2 - Vaishali Nagar
Nr. Amrapali Under Bridge
Raiya Road, Rajkot.
Ph.No-(0281)2440478

3 - Vaishali Nagar
Nr. Amrapali Under Bridge
Raiya Road, Rajkot.
Ph. No-(0281)2471645

- **Step 4:**

Throughput = Total Burst Time/No. of Process

$$(5+3+2+3)/4 = 13/4 = 3.25 \text{ ms}$$

- **Step 5:**

CPU Utilization = Total Estimated Time/Total Estimated Time * 100

$$13/13 * 100 = 100\%$$

One word question answer

Question

Answer

- | | |
|--|--------------------------|
| 1. In which process scheduling the smallest Execution time is selected for execution next. | SJF |
| 2. Formula of avg. turnaround time of Process | TotalTurnAround Time/No. |
| 3. Formula of avg. waiting time of Process | TotalWaitingTime/No.of |

Topic: 5 Explain Round Robin process scheduling algorithm.

Ans.

Detail:

- Round Robin is the preemptive process scheduling algorithm.
- Each process is provided a fix time to execute, it is called a **quantum**.
- Once a process is executed for a given time period, it is preempted, and other process executes for a given time period.

SHREE H. N. SHUKLA COLLEGE OF IT & MGMT.



(Affiliated to Saurashtra University & GTU)

2 - Vaishali Nagar
Nr. Amrapali Under Bridge
Raiya Road, Rajkot.
Ph.No-(0281)2440478

3 - Vaishali Nagar
Nr. Amrapali Under Bridge
Raiya Road, Rajkot.
Ph. No-(0281)2471645

Example:

Suppose there are four processes with process ID's **P1**, **P2**, **P3**, and **P4** and they enter the CPU as follows:

PROCESS ID	ARRIVAL TIME	BURST TIME
P1	0	5 (2)
P2	2	3
P3	3	2
P4	1	3

Quantum: 3

Step 1:

Gant Chart:

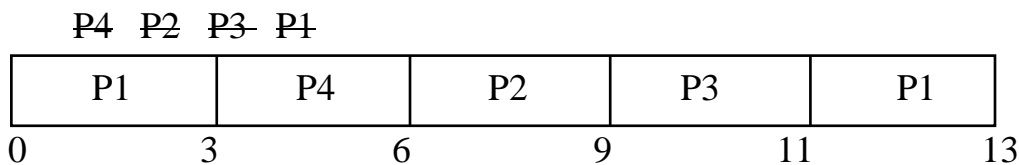

Step 2:

Turn Around Time = Completion Time – Arrival Time

Waiting Time = Turn Around Time – Burst Time

SHREE H. N. SHUKLA COLLEGE OF IT & MGMT.



(Affiliated to Saurashtra University & GTU)

2 - Vaishali Nagar
Nr. Amrapali Under Bridge
Raiya Road, Rajkot.
Ph.No-(0281)2440478

3 - Vaishali Nagar
Nr. Amrapali Under Bridge
Raiya Road, Rajkot.
Ph. No-(0281)2471645

PID	ARRIVAL TIME	BURST TIME	COMPLETION TIME	TURN AROUND TIME	WAITING TIME
P1	0	5	13	13	8
P2	2	3	9	7	4
P3	3	2	11	8	6
P4	1	3	6	5	2

Step 3:

Avg. Turn Around Time = Total Turn Around Time/No. of Process

$$(13+7+8+5)/4 = 33/4 = 8.25$$

Avg. Waiting Time = Total Waiting Time/No. of Process

$$(8+4+6+2)/4 = 20/4 = 5$$

Step 4:

Throughput = Total Burst Time/No. of Process

$$(5+3+2+3)/4 = 13/4 = 3.25$$

Step 5:

CPU Utilization = Total Estimated Time/Total Estimated Time * 100

$$13/13*100 = 100\%$$

SHREE H. N. SHUKLA COLLEGE OF IT & MGMT.



(Affiliated to Saurashtra University & GTU)

2 - Vaishali Nagar
Nr. Amrapali Under Bridge
Raiya Road, Rajkot.
Ph.No–(0281)2440478

3 - Vaishali Nagar
Nr. Amrapali Under Bridge
Raiya Road, Rajkot.
Ph. No–(0281)2471645

One word question answer

Question

Answer

1. Round Robin is which type of process scheduling algorithm? preemptive
2. Each process is provided a fix time to execute, it is called a _____. quantum

Topic:6 Explain Priority process scheduling algorithm with non-preemptive method.

Ans.

Detail:

- Priority scheduling is one of the most common scheduling algorithms in batch systems.
- Each process is assigned a priority. Process with the highest priority is to be executed first and so on.
- Processes with the same priority are executed on first come first served basis.
- Priority can be decided based on memory requirements, time requirements or any other resource requirement.
- Priority Scheduling can be either preemptive or non-preemptive.

Example:

Suppose there are four processes with process ID's **P1, P2, P3, and P4** and they enter the CPU as follows:

PROCESS ID	ARRIVAL TIME	BURST TIME	PRIORITY
P1	0	5	3
P2	2	3	5
P3	3	2	1
P4	1	3	2

SHREE H. N. SHUKLA COLLEGE OF IT & MGMT.



(Affiliated to Saurashtra University & GTU)

2 - Vaishali Nagar
Nr. Amrapali Under Bridge
Raiya Road, Rajkot.
Ph.No–(0281)2440478

3 - Vaishali Nagar
Nr. Amrapali Under Bridge
Raiya Road, Rajkot.
Ph. No–(0281)2471645

Step 1:

Gant Chart:

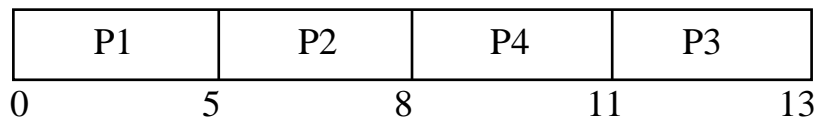

Step 2:

Turn Around Time = Completion Time – Arrival Time

Waiting Time = Turn Around Time – Burst Time

PID	ARRIVAL TIME	BURST TIME	COMPLETION TIME	TURN AROUND TIME	WAITING TIME
P1	0	5	5	5	0
P2	2	3	8	6	3
P3	3	2	13	10	8
P4	1	3	11	10	7

Step 3:

Avg. Turn Around Time = Total Turn Around Time/No. of Process

$$(5+6+10+10)/4 = 31/4 = 7.75$$

Avg. Waiting Time = Total Waiting Time/No. of Process

$$(0+3+8+7)/4 = 18/4 = 4.5$$

Step 4:

Throughput = Total Burst Time/No. of Process

$$(5+3+2+3)/4 = 13/4 = 3.25$$

SHREE H. N. SHUKLA COLLEGE OF IT & MGMT.



(Affiliated to Saurashtra University & GTU)

2 - Vaishali Nagar
Nr. Amrapali Under Bridge
Raiya Road, Rajkot.
Ph.No–(0281)2440478

3 - Vaishali Nagar
Nr. Amrapali Under Bridge
Raiya Road, Rajkot.
Ph. No–(0281)2471645

Step 5:

CPU Utilization = Total Estimated Time/Total Estimated Time * 100

$13/13 * 100 = 100\%$

One word question answer

Question

1. Priority Scheduling can be _____.
2. Each process is assigned a _____.

Answer

preemptive or non-preemptive
priority.

Topic: 7 Explain Priority process scheduling algorithm with preemptive method.

Ans.

Detail:

- Priority scheduling is one of the most common scheduling algorithms in batch systems.
- Each process is assigned a priority. Process with the highest priority is to be executed first and so on.
- Processes with the same priority are executed on first come first served basis.
- Priority can be decided based on memory requirements, time requirements or any other resource requirement.
- Priority Scheduling can be either preemptive or non-preemptive.

Example:

Suppose there are four processes with process ID's **P1, P2, P3, and P4** and they enter the CPU as follows:

SHREE H. N. SHUKLA COLLEGE OF IT & MGMT.



(Affiliated to Saurashtra University & GTU)

2 - Vaishali Nagar
Nr. Amrapali Under Bridge
Raiya Road, Rajkot.
Ph.No-(0281)2440478

3 - Vaishali Nagar
Nr. Amrapali Under Bridge
Raiya Road, Rajkot.
Ph. No-(0281)2471645

PROCESS ID	ARRIVAL TIME	BURST TIME	PRIORITY
P1	0	5(3)	3
P2	2	3	5
P3	3	2	1
P4	1	3	2

Step 1:

Gant Chart:

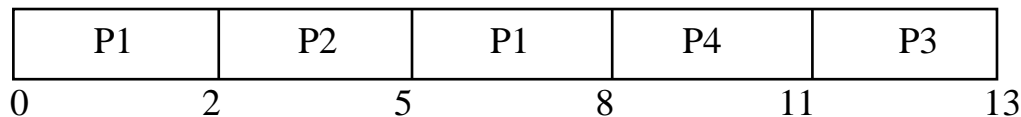

Step 2:

Turn Around Time = Completion Time – Arrival Time

Waiting Time = Turn Around Time – Burst Time

PID	ARRIVAL TIME	BURST TIME	COMPLETION TIME	TURN AROUND TIME	WAITING TIME
P1	0	5	8	8	3
P2	2	3	5	3	0
P3	3	2	13	10	8
P4	1	3	11	10	7

SHREE H. N. SHUKLA COLLEGE OF IT & MGMT.



(Affiliated to Saurashtra University & GTU)

2 - Vaishali Nagar
Nr. Amrapali Under Bridge
Raiya Road, Rajkot.
Ph.No-(0281)2440478

3 - Vaishali Nagar
Nr. Amrapali Under Bridge
Raiya Road, Rajkot.
Ph. No-(0281)2471645

Step 3:

Avg. Turn Around Time = Total Turn Around Time/No. of Process

$$(8+3+10+10)/4 = 31/4 = 7.75$$

Avg. Waiting Time = Total Waiting Time/No. of Process

$$(3+0+8+7)/4 = 18/4 = 4.5$$

Step 4:

Throughput = Total Burst Time/No. of Process

$$(5+3+2+3)/4 = 13/4 = 3.25$$

Step 5:

CPU Utilization = Total Estimated Time/Total Estimated Time * 100

$$13/13*100 = 100\%$$

One word question answer

Question

1. Processes with the same priority are executed on _____ basis
2. Formula to find throughput is _____ of Process

Answer

first come first served
Total Burst Time/No.

SHREE H. N. SHUKLA COLLEGE OF IT & MGMT.



(Affiliated to Saurashtra University & GTU)

2 - Vaishali Nagar
Nr. Amrapali Under Bridge
Raiya Road, Rajkot.
Ph.No–(0281)2440478

3 - Vaishali Nagar
Nr. Amrapali Under Bridge
Raiya Road, Rajkot.
Ph. No–(0281)2471645

UNIT – 2 (Part-1)

Topic :1 what is Deadlocks.

Every process needs some resources to complete its execution. However, the resource is granted in a sequential order.

1. The process requests for some resource.
2. OS grant the resource if it is available otherwise let the process waits.
3. The process uses it and release on the completion.

A Deadlock is a situation where each of the computer process waits for a resource which is being assigned to some another process. In this situation, none of the process gets executed since the resource it needs, is held by some other process which is also waiting for some other resource to be released. Let us assume that there are three processes P1, P2 and P3. There are three different resources R1, R2 and R3. R1 is assigned to P1, R2 is assigned to P2 and R3 is assigned to P3.

After some time, P1 demands for R1 which is being used by P2. P1 halts its execution since it can't complete without R2. P2 also demands for R3 which is being used by P3. P2 also stops its execution because it can't continue without R3. P3 also demands for R1 which is being used by P1 therefore P3 also stops its execution.

Backward Skip 10s Play Video Forward Skip 10s

In this scenario, a cycle is being formed among the three processes. None of the process is progressing and they are all waiting. The computer becomes unresponsive since all the processes got blocked.

SHREE H. N. SHUKLA COLLEGE OF IT & MGMT.



(Affiliated to Saurashtra University & GTU)

2 - Vaishali Nagar
Nr. Amrapali Under Bridge
Raiya Road, Rajkot.
Ph.No–(0281)2440478

3 - Vaishali Nagar
Nr. Amrapali Under Bridge
Raiya Road, Rajkot.
Ph. No–(0281)2471645

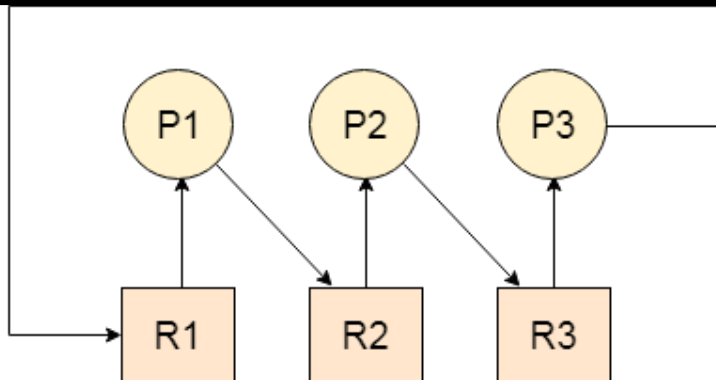

Deadlock Prevention

As we have discussed in the above section, that all four conditions: Mutual Exclusion, Hold and Wait, No preemption, and circular wait if held by a system then causes deadlock to occur. The main aim of the deadlock prevention method is to violate any one condition among the four; because if any of one condition is violated then the problem of deadlock will never occur. As the idea behind this method is simple but the difficulty can occur during the physical implementation of this method in the system.

Avoiding the Deadlock

This method is used by the operating system in order to check whether the system is in a safe state or in an unsafe state. This method checks every step performed by the operating system. Any process continues its execution until the system is in a safe state. Once the system enters into an unsafe state, the operating system has to take a step back.

Basically, with the help of this method, the operating system keeps an eye on each allocation, and make sure that allocation does not cause any deadlock in the system.

Deadlock detection and recovery

With this method, the deadlock is detected first by using some algorithms of the resource-allocation graph. This graph is mainly used to represent the allocations of various resources to different processes. After the detection of deadlock, a number of methods can be used in order to recover from that deadlock.

SHREE H. N. SHUKLA COLLEGE OF IT & MGMT.



(Affiliated to Saurashtra University & GTU)

2 - Vaishali Nagar
Nr. Amrapali Under Bridge
Raiya Road, Rajkot.
Ph.No–(0281)2440478

3 - Vaishali Nagar
Nr. Amrapali Under Bridge
Raiya Road, Rajkot.
Ph. No–(0281)2471645

One way is **preemption** by the help of which a resource held by one process is provided to another process.

The second way is to **roll back**, as the operating system keeps a record of the process state and it can easily make a process roll back to its previous state due to which deadlock situation can be easily eliminate.

The third way to overcome the deadlock situation is by killing one or more processes.

UNIT – 2 (Part-2)

Topic: 1 Explain physical memory and virtual memory.

Ans.

Detail:

Physical Memory:

- Physical memory is the actual real memory used in RAM.
- Physical memory is the only memory that is directly accessible to the CPU.
- CPU reads the instructions stored in the physical memory and executes them continuously.
- The data that is operated will also be stored in physical memory in uniform manner.

Virtual Memory:

- Virtual memory as the name suggests is not real.
- The OS uses virtual memory as a memory management technique in which non-contiguous memory is presented to software as contiguous memory.
- Virtual memory is one classification of memory which was created by using the hard disk for simulating additional RAM, the addressable space available for the user.
- Virtual addresses are mapped into real addresses.

SHREE H. N. SHUKLA COLLEGE OF IT & MGMT.



(Affiliated to Saurashtra University & GTU)

2 - Vaishali Nagar
Nr. Amrapali Under Bridge
Raiya Road, Rajkot.
Ph.No–(0281)2440478

3 - Vaishali Nagar
Nr. Amrapali Under Bridge
Raiya Road, Rajkot.
Ph. No–(0281)2471645

One word question answer

Question

1. What is physical memory?
2. Data stored in physical memory in_____.
3. Virtual addresses are mapped into _____.

Answer

actual real memory
uniform manner
real addresses.

Topic: 2 What is memory allocation?

Ans.

Detail:

- Memory allocation is a process by which computer programs and services are assigned with physical or virtual memory space.
- Memory allocation is the process of reserving a partial or complete portion of computer memory for the execution of programs and processes.
- Memory allocation is achieved through a process known as memory management.
- Memory allocation is primarily a computer hardware operation but is managed through operating system and software applications.
- Memory allocation process is quite similar in physical and virtual memory management.

Memory allocation has two core types.

- **Static Memory Allocation:** The program is allocated memory at compile time.
- **Dynamic Memory Allocation:** The programs are allocated with memory at run time.

SHREE H. N. SHUKLA COLLEGE OF IT & MGMT.



(Affiliated to Saurashtra University & GTU)

2 - Vaishali Nagar
Nr. Amrapali Under Bridge
Raiya Road, Rajkot.
Ph.No-(0281)2440478

3 - Vaishali Nagar
Nr. Amrapali Under Bridge
Raiya Road, Rajkot.
Ph. No-(0281)2471645

One word question answer

Question

Answer

- | | | | |
|--|-----------|--------|----|
| 1. Memory allocation is the process of _____. | assigning | space | to |
| memory | | | |
| 2. The program is allocated memory at compile time in____. | Static | Memory | |
| Allocation | | | |
| 3. The programs are allocated with memory at run time in_____. | Dynamic | Memory | |
| Allocation | | | |

Topic: 3 What is fragmentation?

Ans.

Detail:

- In a computer storage system, as processes are loaded and removed from memory, the free memory space is broken into small pieces.
- In this way memory space used inefficiently, so the capacity or performance of the system may degrade.
- The conditions of the fragmentation depend on the system of memory allocation. In most of the cases, memory space is wasted.
- Sometimes it happens that memory blocks cannot be allocated to processes due to their small size and memory blocks remain unused. This problem is known as fragmentation.

Types of fragmentation

1. External fragmentation
2. Internal fragmentation

1) External fragmentation

External fragmentation exists when total memory space exists to satisfy a request, but it is not contiguous; storage is fragmented into many holes.

SHREE H. N. SHUKLA COLLEGE OF IT & MGMT.



(Affiliated to Saurashtra University & GTU)

2 - Vaishali Nagar
Nr. Amrapali Under Bridge
Raiya Road, Rajkot.
Ph.No–(0281)2440478

3 - Vaishali Nagar
Nr. Amrapali Under Bridge
Raiya Road, Rajkot.
Ph. No–(0281)2471645

2) Internal fragmentation

An approach is to allocate small holes as part of the larger request. Thus, the allocated memory may be larger than the requested memory.

Topic: 4 Explain contiguous memory allocation?

Ans.

Detail:

- Contiguous memory allocation is a classical memory allocation model that assigns a process consecutive memory blocks (that is, memory blocks having consecutive addresses).
- Contiguous memory allocation is one of the oldest memory allocation schemes.
- When a process needs to execute, memory is requested by the process. The size of the process is compared with the amount of contiguous main memory available to execute the process. If sufficient contiguous memory is found, the process is allocated memory to start its execution.
- Otherwise, it is added to a queue of waiting processes until sufficient free contiguous memory is available.

There are different types of contiguous memory allocation in operating system.

1. **Single partition allocation**
2. **Multiple Partition allocation**
3. **Dynamic partition allocation**

1. Single Partition Allocation

In this scheme Operating system is residing in low memory and user processes are executing in higher memory.

SHREE H. N. SHUKLA COLLEGE OF IT & MGMT.



(Affiliated to Saurashtra University & GTU)

2 - Vaishali Nagar
Nr. Amrapali Under Bridge
Raiya Road, Rajkot.
Ph.No-(0281)2440478

3 - Vaishali Nagar
Nr. Amrapali Under Bridge
Raiya Road, Rajkot.
Ph. No-(0281)2471645

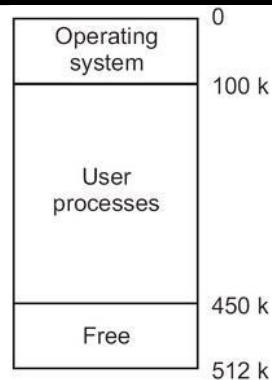

Advantages

- It is simple.
- It is easy to understand and use.

Disadvantages

- Poor utilization of processor and memory.
- Users job is limited to the size of available memory.

2. Multiple Partition Allocation

User memory is divided into more than one partitions. There are two types fixed partition or static partition and variable partition or dynamic partition.

- **Fixed partition** has equal or unequal size of partitions and a partition is allocated to an active process in the multiprogramming system, however it may suffer from internal and external fragmentations, it supports only fixed number of active processes.
- **Variable partition** has equal or unequal size of partitions and these partitions are created dynamically. A block or hole is available memory or free partitions. Variable partition has no internal fragmentation and its better utilization of memory than fixed partition. However, variable partition suffers from external fragmentation and it has overhead of compaction.

3. Dynamic Allocation Algorithms

SHREE H. N. SHUKLA COLLEGE OF IT & MGMT.



(Affiliated to Saurashtra University & GTU)

2 - Vaishali Nagar
Nr. Amrapali Under Bridge
Raiya Road, Rajkot.
Ph.No–(0281)2440478

3 - Vaishali Nagar
Nr. Amrapali Under Bridge
Raiya Road, Rajkot.
Ph. No–(0281)2471645

If more than one empty space or blocks are available for an active process, then the operating system decides how to select a best space or block using dynamic allocation algorithms. These algorithms are as following:

- **First fit:** It allocated the first hole that is big enough to process, this started from the beginning to search such empty hole, so first fit algorithm is simple to implement and faster to use.
- **Best fit:** This allocates smallest hole that is big enough for process. This is fast when all empty blocks or holes sorted in increasing order of size. Best fit minimizes internal fragmentation.
- **Worst fit:** This allocates largest hole that is empty for process. This creates maximum internal fragmentation. Worst fit is fast when all empty blocks or holes sorted in decreasing order of size.

One word question answer

Question	Answer
1. Which is the oldest memory allocation schemes? allocation	Contiguous memory
2. Which allocation assigns a process consecutive memory block? memory allocation	Contiguous
3. Where user memory is divided into more than one partitions. Allocation	Multiple Partition

Topic: 5 Explain noncontiguous memory allocation?

Ans.

Detail:

In the non-contiguous memory allocation, a process will acquire the memory space, but it is not at one place it is at the different locations according to the process requirement.

SHREE H. N. SHUKLA COLLEGE OF IT & MGMT.



(Affiliated to Saurashtra University & GTU)

2 - Vaishali Nagar
Nr. Amrapali Under Bridge
Raiya Road, Rajkot.
Ph.No-(0281)2440478

3 - Vaishali Nagar
Nr. Amrapali Under Bridge
Raiya Road, Rajkot.
Ph. No-(0281)2471645

- This technique of non-contiguous memory allocation reduces the wastage of memory which leads to internal and external fragmentation.
- This utilizes all the free memory space which is created by a different process.
- In this example, process P can be divided into two parts of equal size – 2KB.
- Hence one part of process P can be allocated to first 2KB space of main memory and other part of process P can be allocated to second 2KB space of main memory.
- Below diagram will explain in better way:

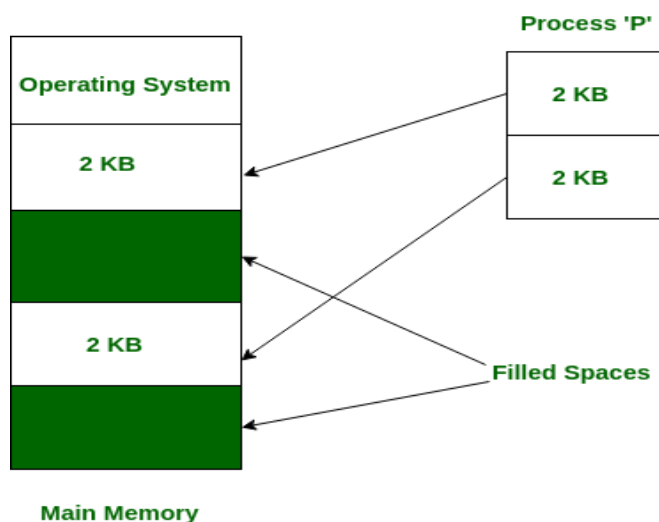

There are two types of noncontiguous memory allocation.

1. **Paging**
2. **Segmentation**

One word question answer

Question

Answer

1. Which memory allocation reduces wastage of memory. Noncontiguous memory allocation
2. Which allocation a process will acquire the memory space at the different locations? Noncontiguous memory allocation
3. Which are two types of noncontiguous memory allocation? Paging & Segmentation

SHREE H. N. SHUKLA COLLEGE OF IT & MGMT.



(Affiliated to Saurashtra University & GTU)

2 - Vaishali Nagar
Nr. Amrapali Under Bridge
Raiya Road, Rajkot.
Ph.No–(0281)2440478

3 - Vaishali Nagar
Nr. Amrapali Under Bridge
Raiya Road, Rajkot.
Ph. No–(0281)2471645

Topic: 6 Explain virtual memory using paging.

Ans.

Detail:

- Paging is a method or techniques which is used for non-contiguous memory allocation.
- It is a fixed size partitioning theme (scheme).
- In paging, both main memory and secondary memory are divided into equal fixed size partitions.

- **Page:** A fixed-length contiguous block of virtual memory residing on disk.
- **Frame:** A fixed-length contiguous block located in RAM; whose sizing is identical to pages.

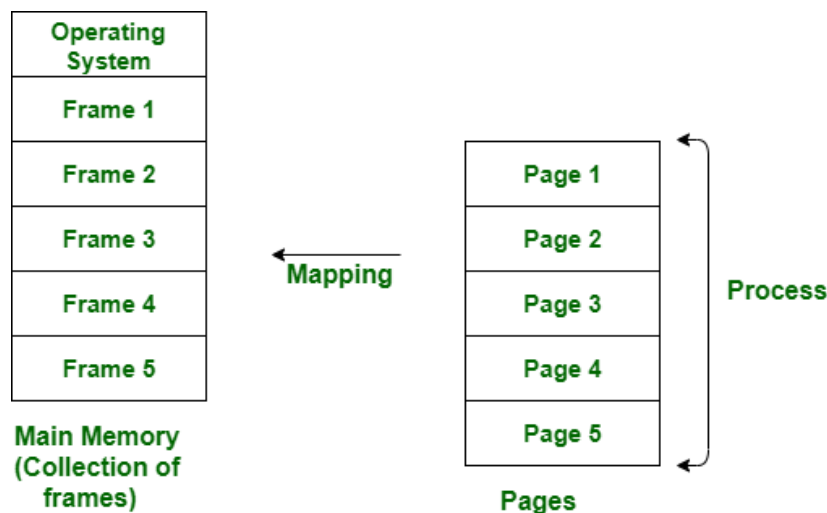

One word question answer

Question

1. Which is a fixed size partitioning theme?

2. Paging is a method or techniques which is used for?

allocation

Answer

Paging

Non-contiguous memory

SHREE H. N. SHUKLA COLLEGE OF IT & MGMT.



(Affiliated to Saurashtra University & GTU)

2 - Vaishali Nagar
Nr. Amrapali Under Bridge
Raiya Road, Rajkot.
Ph.No-(0281)2440478

3 - Vaishali Nagar
Nr. Amrapali Under Bridge
Raiya Road, Rajkot.
Ph. No-(0281)2471645

Topic: 7 Explain virtual memory using segmentation.

Ans.

Detail:

- The process known as segmentation is a virtual process that creates address spaces of various sizes in a computer system, called segments.
- Each segment is a different virtual address space that directly corresponds to process objects.
- When a process executes, segmentation assigns related data into segments for faster processing.
- The segmentation function maintains a segment table that includes physical addresses of the segment, size, and other data.

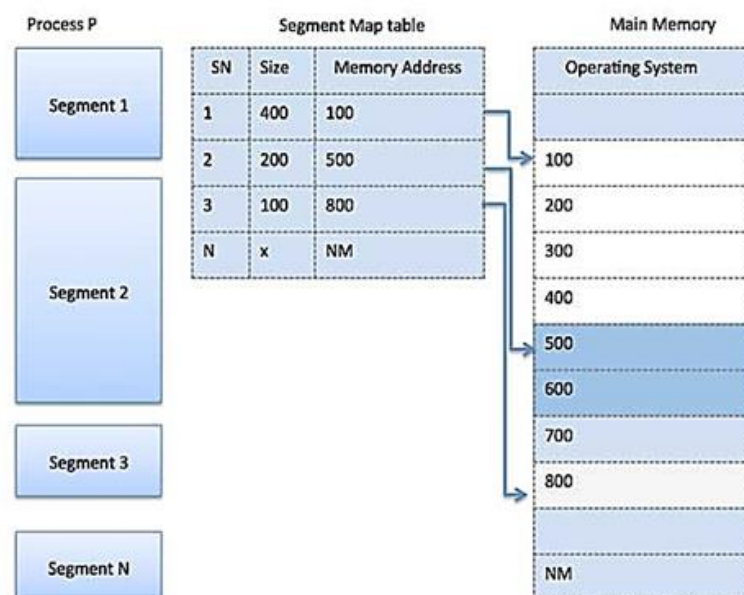

SHREE H. N. SHUKLA COLLEGE OF IT & MGMT.



(Affiliated to Saurashtra University & GTU)

2 - Vaishali Nagar
Nr. Amrapali Under Bridge
Raiya Road, Rajkot.
Ph.No-(0281)2440478

3 - Vaishali Nagar
Nr. Amrapali Under Bridge
Raiya Road, Rajkot.
Ph. No-(0281)2471645

One word question answer

Question

1. The segmentation function maintains a _____
2. Segment table contains _____
other data

Answer

segment table
physical addresses, size, &

Topic: 8 Explain difference between paging and segmentation.

Ans.

Detail:

	Paging	Segmentation
1.	IN PAGING, PROGRAM IS DIVIDED INTO FIXED OR MOUNTED SIZE PAGES.	IN SEGMENTATION, PROGRAM IS DIVIDED INTO VARIABLE SIZE SECTIONS.
2.	For paging operating system is accountable.	For segmentation compiler is accountable.
3.	Page size is determined by hardware.	Here, the section size is given by the user.
4.	It is faster in the comparison of segmentation.	Segmentation is slow.
5.	Paging could result in internal fragmentation.	Segmentation could result in external fragmentation.
6.	In paging, logical address is split into page number and page offset.	Here, logical address is split into section number and section offset.

SHREE H. N. SHUKLA COLLEGE OF IT & MGMT.



(Affiliated to Saurashtra University & GTU)

2 - Vaishali Nagar
Nr. Amrapali Under Bridge
Raiya Road, Rajkot.
Ph.No–(0281)2440478

3 - Vaishali Nagar
Nr. Amrapali Under Bridge
Raiya Road, Rajkot.
Ph. No–(0281)2471645

UNIT – 3 (Part-1)

Getting Started with Unix, Unix Shell Command, Text Editing With vi Editor

Topic: 1 Explain UNIX Architecture.

Ans.

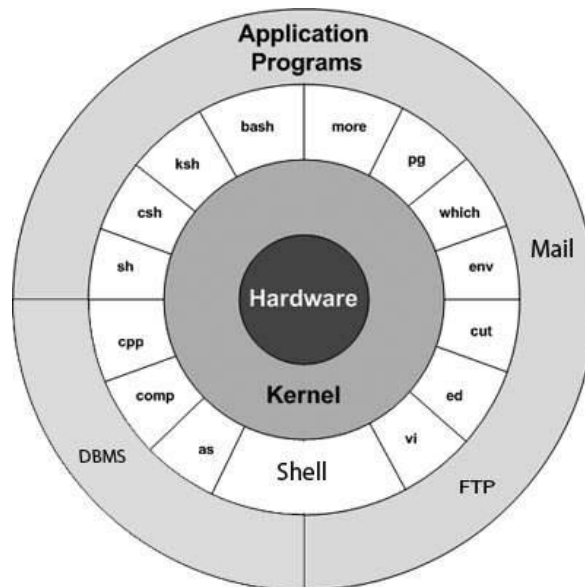

Detail:

- The UNIX operating system is a set of programs that act as a link between the computer and the user.
- UNIX was originally developed in 1969 by a group of AT&T employees Ken Thompson, Dennis Ritchie at Bell Labs.
- The computer program that allocates the system resources and coordinates all the details of the computer's internal is called the 'operating system' or the 'kernel'.
- Users communicate with the kernel through a program known as the **shell**.
- The shell is a command line interpreter; it translates commands entered by the user and converts them into a language that is understood by the kernel.

SHREE H. N. SHUKLA COLLEGE OF IT & MGMT.



(Affiliated to Saurashtra University & GTU)

2 - Vaishali Nagar
Nr. Amrapali Under Bridge
Raiya Road, Rajkot.
Ph.No–(0281)2440478

3 - Vaishali Nagar
Nr. Amrapali Under Bridge
Raiya Road, Rajkot.
Ph. No–(0281)2471645

The main concept that unites all the versions of Unix is the following four basics –

- **Kernel**

- The kernel is the heart of the operating system.
- It interacts with the hardware and most of the tasks like memory management, task scheduling and file management.

- **Shell**

- The shell is the utility that processes your requests.
- When you type in a command at your terminal, the shell interprets the command and calls the program that you want.
- C Shell, Bourne Shell and Korn Shell are the most famous shells which are available with most of the Unix variants.

- **Commands and Utilities**

- There are various commands and utilities which you can make use of in your day-to-day activities.
- **cp, mv, cat** and **grep**, etc. are few examples of commands and utilities.
- There are over 250 standard commands plus numerous others provided through 3rd party software.
- All the commands come along with various options.

- **Files and Directories**

- All the data of Unix is organized into files.
- All files are then organized into directories.
- These directories are further organized into a tree-like structure called the **file system**.

SHREE H. N. SHUKLA COLLEGE OF IT & MGMT.



(Affiliated to Saurashtra University & GTU)

2 - Vaishali Nagar
Nr. Amrapali Under Bridge
Raiya Road, Rajkot.
Ph.No–(0281)2440478

3 - Vaishali Nagar
Nr. Amrapali Under Bridge
Raiya Road, Rajkot.
Ph. No–(0281)2471645

One word question answer

Question

3. UNIX was originally developed in_____.
4. Unix was developed by.
5. How many commands in Unix?

Answer

- 1969
Ken Thompson, Dennis Ritchie
250

Topic: 2 Explain UNIX features.

Ans.

Detail:

- The following are the Unix Features.

Portability:

- The system is written in high-level language making it easier to read, understand, change and therefore move to other machines.
- The code can be changed and compiled on a new machine.

Machine-independence:

- The System hides the machine architecture from the user, making it easier to write applications that can run on micros and mainframes.

Multi-Tasking:

- UNIX is a powerful multi-tasking operating system; it means when a active task in process, there can be a simultaneous background process working too.
- UNIX handles these active and background threads efficiently and manages the system resources in a fair-share manner.

Multi-User Operations:

- UNIX is a multi-user system designed to support a group of users simultaneously.

SHREE H. N. SHUKLA COLLEGE OF IT & MGMT.



(Affiliated to Saurashtra University & GTU)

2 - Vaishali Nagar
Nr. Amrapali Under Bridge
Raiya Road, Rajkot.
Ph.No–(0281)2440478

3 - Vaishali Nagar
Nr. Amrapali Under Bridge
Raiya Road, Rajkot.
Ph. No–(0281)2471645

- The system allows for the sharing of processing power and peripheral resources, while at the same time providing excellent security features.

Hierarchical File System:

- UNIX uses a hierarchical file structure to store information.
- This structure has the maximum flexibility in grouping information in a way that reflects its natural state. It allows for easy maintenance and efficient implementation.

UNIX shell:

- UNIX has a simple user interface called the shell that has the power to provide the services that the user wants.
- It protects the user from having to know the intricate hardware details.

One word question answer

Question

1. Write any 2 features of Unix.

Answer

Multi-Tasking, Unix Shell

Topic: 3 Explain types of shell in UNIX.

Ans.

Detail:

- A Shell provides you with an interface to the **Unix** system.
- It gathers input from you and executes programs based on that input.
- When a program finishes executing, it displays that program's output.
- There are different shells available in **UNIX**.

1. The Bourne Shell

- The **Bourne shell (sh)**, written by **Steve Bourne** at **AT&T Bell Labs**, is the original UNIX shell.
- It is the preferred shell for shell programming because of its compactness and speed.

SHREE H. N. SHUKLA COLLEGE OF IT & MGMT.



(Affiliated to Saurashtra University & GTU)

2 - Vaishali Nagar
Nr. Amrapali Under Bridge
Raiya Road, Rajkot.
Ph.No–(0281)2440478

3 - Vaishali Nagar
Nr. Amrapali Under Bridge
Raiya Road, Rajkot.
Ph. No–(0281)2471645

- Its command full-path name is `/bin/sh`. User default prompt is `$`.

2. The C Shell

- The **C shell (csh)**, written by **Bill Joy** at the **University of California at Berkeley**.
- Includes convenient programming features, such as built-in arithmetic syntax.
- Its command full-path name is `/bin/csh`. User default prompt is `hostname %`.

3. The Korn Shell

- The **Korn shell (ksh)**, written by **David Korn** at **AT&T Bell Labs**
- It supports everything in the Bourne shell. Have interactive features comparable to those in the C shell.
- It is faster than the C shell.
- Its command full-path name is `/bin/ksh`. User default prompt is `$`.

4. The Bourne-Again Shell

- The **Bourne-Again shell (bash)** is compatible to the Bourne shell.
- It use features from the Korn and C shells.
- Have arrow keys that are automatically mapped for command recall and editing.
- It's Command full-path name is `/bin/bash`.

One word question answer

Question

5. The Bourne shell written by.
6. The C shell written by.
7. The Korn shell written by.

Answer

Steve Bourne
Bill Joy
David Korn

SHREE H. N. SHUKLA COLLEGE OF IT & MGMT.



(Affiliated to Saurashtra University & GTU)

2 - Vaishali Nagar
Nr. Amrapali Under Bridge
Raiya Road, Rajkot.
Ph.No–(0281)2440478

3 - Vaishali Nagar
Nr. Amrapali Under Bridge
Raiya Road, Rajkot.
Ph. No–(0281)2471645

Topic: 4 Explain UNIX file system.

Ans.

Detail:

- The UNIX file system is a methodology for logically organizing and storing large quantities of data such that the system is easy to manage.
- A file can be informally defined as a collection of data. A file is the smallest unit of storage in the UNIX file system.
- The following system directories are present in most UNIX file systems:
 - */* - the root users' home directory.
 - */bin* - short for binaries, this is the directory where many commonly used executable commands reside
 - */dev* - contains device specific files
 - */etc* - contains system configuration files
 - */lib* - contains all library files
 - */mnt* - contains device files related to mounted devices
 - */proc* - contains files related to system processes
 - */sbin* - system binary files reside here. If there is no *sbin* directory on your system, these files most likely reside in *etc*
 - */tmp* - storage for temporary files which are periodically removed from the filesystem
 - */usr* - also contains executable commands.

One word question answer

Question

3. Which directory contains device specific files?
4. Which directory contains system configuration files

Answer

/dev
processors? */etc*

SHREE H. N. SHUKLA COLLEGE OF IT & MGMT.



(Affiliated to Saurashtra University & GTU)

2 - Vaishali Nagar
Nr. Amrapali Under Bridge
Raiya Road, Rajkot.
Ph.No–(0281)2440478

3 - Vaishali Nagar
Nr. Amrapali Under Bridge
Raiya Road, Rajkot.
Ph. No–(0281)2471645

Topic: 5 Explain types of files in UNIX.

Ans.

Detail:

- The UNIX file system contains several different types of files:
- **Ordinary Files**
 - Used to store your information, such as some text you have written.
 - Always located within/under a directory file.
 - Do not contain other files.
- **Directories**
 - Branching points in the hierarchical tree.
 - Used to organize groups of files.
 - May contain ordinary files, special files or other directories.
- **Special Files**
 - Used to represent a real physical device such as a printer, tape drive or terminal, used for Input/output (I/O) operations.

One word question answer

Question	Answer
3. How many file types in unix?	3

Topic: 6 Explain UNIX file and directory permissions.

Ans.

Detail:

- File ownership is an important component of Unix that provides a secure method for storing files. Every file in Unix has the following attributes –

SHREE H. N. SHUKLA COLLEGE OF IT & MGMT.



(Affiliated to Saurashtra University & GTU)

2 - Vaishali Nagar
Nr. Amrapali Under Bridge
Raiya Road, Rajkot.
Ph.No–(0281)2440478

3 - Vaishali Nagar
Nr. Amrapali Under Bridge
Raiya Road, Rajkot.
Ph. No–(0281)2471645

- **Owner permissions** – The owner's permissions determine what actions the owner of the file can perform on the file.
- **Group permissions** – The group's permissions determine what actions a user, who is a member of the group that a file belongs to, can perform on the file.
- **Other (world) permissions** – The permissions for others indicate what action all other users can perform on the file.

The Permission Indicators

- While using **ls -l** command, it displays various information related to file permission as follows –

```
$ls -l /home/abc  
-rwxr-xr-- 1 abc users 1024 Nov 2 00:10 myfile  
drwxr-xr--- 1 abc users 1024 Nov 2 00:10 mydir
```

- Here, the first column represents different access modes, i.e., the permission associated with a file or a directory.
- The permissions are broken into groups of threes, and each position in the group denotes a specific permission, in this order: read (r), write (w), execute (x) –
- The first three characters (2-4) represent the permissions for the file's owner. For example, **-rwxr-xr--** represents that the owner has read (r), write (w) and execute (x) permission.
- The second group of three characters (5-7) consists of the permissions for the group to which the file belongs. For example, **-rwxr-xr--** represents that the group has read (r) and execute (x) permission, but no write permission.
- The last group of three characters (8-10) represents the permissions for everyone else. For example, **-rwxr-xr--** represents that there is **read (r)** only permission.

File/Directory Access Modes

- The permissions of a file are the first line of defense in the security of a Unix system.
- The basic building blocks of Unix permissions are the **read**, **write**, and **execute** permissions, which have been described below –

SHREE H. N. SHUKLA COLLEGE OF IT & MGMT.



(Affiliated to Saurashtra University & GTU)

2 - Vaishali Nagar
Nr. Amrapali Under Bridge
Raiya Road, Rajkot.
Ph.No–(0281)2440478

3 - Vaishali Nagar
Nr. Amrapali Under Bridge
Raiya Road, Rajkot.
Ph. No–(0281)2471645

Read

Grants the capability to read, i.e., view the contents of the file.

Write

Grants the capability to modify, or remove the content of the file.

Execute

User with execute permissions can run a file as a program.

One word question answer

Question

Answer

- | | |
|--|----------------------|
| 1.How many types of permissions in unix? | 3 |
| 4. Access modes in unix? | Read, write, execute |

UNIT – 3 (Part-2)

Topic: 1 Unix Commands.

Ans.

Detail:

Commands	
Login Commands	Passwd, logout, who, who m i, clear
File & Directory related command	Ls, cat, cd, pwd, mv, cp, ln, rm, rmdir, mkdir, umask, chmod, chown, chgrp,

SHREE H. N. SHUKLA COLLEGE OF IT & MGMT.



(Affiliated to Saurashtra University & GTU)

2 - Vaishali Nagar
Nr. Amrapali Under Bridge
Raiya Road, Rajkot.
Ph.No-(0281)2440478

3 - Vaishali Nagar
Nr. Amrapali Under Bridge
Raiya Road, Rajkot.
Ph. No-(0281)2471645

	find, pg, more, less, head, tail, wc, touch
Operator & redirecting piping	< , > , << , >> ,
Finding pattern in file	Grep, fgrep, egrep
Working with Column and fields	Sort, uniq
Tools for sorting	
Comparing File	Cmp, comm, diff
Changing information in file	Tr, sed
Examining file content	Od
Tools for mathematical calculation	Bc, factor
Tools for display date and time	Cal, date
Communication	telnet, wall, motd, write, mail, news, finger
Process related commands	Ps, nice, kill, at, batch, cron, crontab, wait, sleep
Mounting file system	Mount
Demount file system	unmount

Unix Shell Commands

Login Commands

Passwd

- Purpose : This command is used to change the password.
- Usage : It first asks for the old password this password is checked with the stored password for this user, if it is valid it asks for the new password and confirm password.
- **General rules for entering a valid password**

SHREE H. N. SHUKLA COLLEGE OF IT & MGMT.



(Affiliated to Saurashtra University & GTU)

2 - Vaishali Nagar
Nr. Amrapali Under Bridge
Raiya Road, Rajkot.
Ph.No–(0281)2440478

3 - Vaishali Nagar
Nr. Amrapali Under Bridge
Raiya Road, Rajkot.
Ph. No–(0281)2471645

- It must contain at least one numeric or special character within first eight characters.
- It must contain two alphabetic characters
- The length of password must be at least 3 characters and not more than 255 characters.
- It must not be same as old password. It must differ by at least 3 positions.
- It must not be same as login id
- These passwords are case sensitive.

Options

- -d, ---delete Delete a user's password (make it empty).
- -l, ---lock Lock the named account. This option disables an account by changing the password
- -u, ---unlock Unlock the account.

- Syntax : \$passwd
- Example : \$passwd
- Output : old password :

new password :

confirm password :

logout / exit

- Def : This command terminate the session and quite the current login.
- Syntax : \$logout
- Example : \$logout
- Output : Output may be either login screen or login command depend upon OS.

who

- Def. : This command displays all the users who are currently log into the system. It returns the username, the terminal (Device id) and login time of the user.
- Syntax : \$who
- Example : \$who

who am I

SHREE H. N. SHUKLA COLLEGE OF IT & MGMT.



(Affiliated to Saurashtra University & GTU)

2 - Vaishali Nagar
Nr. Amrapali Under Bridge
Raiya Road, Rajkot.
Ph.No–(0281)2440478

3 - Vaishali Nagar
Nr. Amrapali Under Bridge
Raiya Road, Rajkot.
Ph. No–(0281)2471645

- Def : Instead of getting information about all user who are currently login, if you want to get information about yourself then who am I is used.
- Who command with the arguments “am I” gives the details of the user who executes this command.
- Syntax : \$who am i
- Example : \$who am i

Clear

- Def : This command clears the terminal screen. It takes no arguments or ignores any command line arguments. It works similar to that of cls command in Dos.
- Syntax : \$clear
- Example : \$clear

Files & Directory Commands

Command Name	Definition	Syntax & Ex	Options
ls	ls (List Directories) : It lists the directories and files in the current directory.	Syntax : \$ls Example : \$ls -l Output : Detail list of files and directories.	ls -l : Long listing of file showing with seven attributes (File Type, Permission Links, Owner, Group, File Size, Last Modified, File Name) ls -n : It displays the user group id with long list format. ls -a : It is used to display hidden files. ls -R : It displays Folder and

SHREE H. N. SHUKLA COLLEGE OF IT & MGMT.



(Affiliated to Saurashtra University & GTU)

2 - Vaishali Nagar
Nr. Amrapali Under Bridge
Raiya Road, Rajkot.
Ph.No-(0281)2440478

3 - Vaishali Nagar
Nr. Amrapali Under Bridge
Raiya Road, Rajkot.
Ph. No-(0281)2471645

			Subfolder.
cat	This command is generally used to create a file, see the content of the file and append data to a file.	Syntax 1 : Creating a file \$cat > filename Syntax 2 : Append data to a file \$cat >> filename Syntax 3 : See content of a file \$cat filename Example : \$cat > abc.txt hi hello ^z	
cd	It is stands for change directory. Using this command you can move from one directory to another by changing the directory in inner structure.	Syntax : \$cd abc Example : \$cd abc Output : /abc	
cd..	It is stands for change directory. This command is used to move from one directory to another directory in uplevel in directory.	Syntax : \$cd .. Example : /abc cd..	
rm	It is stands for remove. It is used to delete the link to the file. It doesn't mean	Syntax : \$rm file1 file2 Example : \$rm	

SHREE H. N. SHUKLA COLLEGE OF IT & MGMT.



(Affiliated to Saurashtra University & GTU)

2 - Vaishali Nagar
Nr. Amrapali Under Bridge
Raiya Road, Rajkot.
Ph.No–(0281)2440478

3 - Vaishali Nagar
Nr. Amrapali Under Bridge
Raiya Road, Rajkot.
Ph. No–(0281)2471645

	that the file is physically deleted. You can remove multiple files using a single command.	abc.txt xyz.txt 9	
mkdir	It is stands for make directory. This command is used to create directories and sub directories. We can create multiple directories using a single command.	Syntax : \$mkdir d1 d2 Example : \$mkdir d1 d2	
rmdir	It is stands for remove directory. It is used to remove the one or more directories. If the directory contains the files, it can not be remove and error message “directory is not empty” is return to the user.	Syntax : \$rmdir <d1> <d2> Example : \$rmdir d1 d2	
ln	It is stands for link. This command create a link file from source file.	Syntax : \$ln <file1> <file2> Example : \$cat > abc.txt hi to all ^z \$ln abc.txt xyz.txt \$cat xyz.txt hi to all	

SHREE H. N. SHUKLA COLLEGE OF IT & MGMT.



(Affiliated to Saurashtra University & GTU)

2 - Vaishali Nagar
Nr. Amrapali Under Bridge
Raiya Road, Rajkot.
Ph.No–(0281)2440478

3 - Vaishali Nagar
Nr. Amrapali Under Bridge
Raiya Road, Rajkot.
Ph. No–(0281)2471645

<p>wc</p>	<p>It is stands for word count. It is used to count the number of lines, words and characters in the given file name.</p>	<p>Syntax:\$wc [option] <file name></p> <p>Example 1 (count no. of lines): \$cat abc.txt hi to all \$wc -l abc.txt Output : 3</p> <p>Example 2 (count no. of words): \$wc -w abc.txt Output : 3</p> <p>Example 3 (count no. of characters): \$wc -c abc.txt Output : 7</p> <p>Example 4 (count no. of lines, words, characters): \$wc abc.txt Output : 3 3 7</p>	<ol style="list-style-type: none"> 1. wc -l Display no. of lines. 2. wc -c: Display no. of characters. 3. wc -w :Display no. of words.
<p>head</p>	<p>It is used to display the line from the top of the file. If no argument is passed to this command, by default it displays first 10 lines of the files.</p>	<p>Syntax : \$head [-n] <file name> (n is any positive no.)</p> <p>Example :</p> <ol style="list-style-type: none"> 1) Without option \$head abc.txt 	

SHREE H. N. SHUKLA COLLEGE OF IT & MGMT.



(Affiliated to Saurashtra University & GTU)

2 - Vaishali Nagar
Nr. Amrapali Under Bridge
Raiya Road, Rajkot.
Ph.No-(0281)2440478

3 - Vaishali Nagar
Nr. Amrapali Under Bridge
Raiya Road, Rajkot.
Ph. No-(0281)2471645

		1 2 3 4 5 6 7 8 9 10 2) With option \$head -2 abc.txt 1 2	
tail	It is used to display the bottom lines of a file. If no argument are specify it also display 10 lines from the bottom of the files.	Syntax : \$tail [-arg] <file name> (arg is number of lines to be display) Example : 1) With argument \$tail -3 abc.txt 9 10 11 2) Without argument \$tail abc.txt 2 3 4 5	
touch	This command changes the last modification time of	Syntax : \$ touch <file name> Example :	

SHREE H. N. SHUKLA COLLEGE OF IT & MGMT.



(Affiliated to Saurashtra University & GTU)

2 - Vaishali Nagar
Nr. Amrapali Under Bridge
Raiya Road, Rajkot.
Ph.No–(0281)2440478

3 - Vaishali Nagar
Nr. Amrapali Under Bridge
Raiya Road, Rajkot.
Ph. No–(0281)2471645

	the file	\$ touch abc.txt \$ls -l	
more	If the file size is larger than the screen then the content of the file with scroll up until it reach at the end of file. User is only able to view the last page.	Syntax : \$ more <file name>	
less	This command is simmilar to that more command but it allows background movement in the file.	Syntax : \$ less <file name> Example : \$ less abc.txt	
cp	This command is used for copy. This command is used to copy a single file.	Syntax : \$ cp <source file> <destination file> Example : \$cp abc.txt xyz.txt	
mv	It is stands for move. It is used to rename a file as well as move a file to a different directory.	Syntax : for rename \$mv <source file> <destination file> for move a file or directory \$mv <filename> <path with new name> Example 1 : For	

SHREE H. N. SHUKLA COLLEGE OF IT & MGMT.



(Affiliated to Saurashtra University & GTU)

2 - Vaishali Nagar
Nr. Amrapali Under Bridge
Raiya Road, Rajkot.
Ph.No–(0281)2440478

3 - Vaishali Nagar
Nr. Amrapali Under Bridge
Raiya Road, Rajkot.
Ph. No–(0281)2471645

		<p>rename a file \$mv abc.txt xyz.txt Output : xyz.txt is renamed file of abc.txt Example 2 : For move a file \$mv xyz.txt xyz/ Output : xyz.txt moved to xyz directory</p>	
find	<p>This command examines the directory tree to for files matching the criteria and then takes action on the selected files</p>	<p>Syntax :for find file \$find name <filename> for find files within directory \$find dir type f Example 1 : Find file \$find name file1 Output : /dirb/file1</p>	

Operator & redirecting piping

- Redirection is a feature in Linux such that when executing a command, you can change the standard input/output devices. The basic workflow of any Linux command is that it takes an input and give an output.
- The standard input (stdin) device is the keyboard.
- The standard output (stdout) device is the screen.
- With redirection, the above standard input/output can be changed.

SHREE H. N. SHUKLA COLLEGE OF IT & MGMT.



(Affiliated to Saurashtra University & GTU)

2 - Vaishali Nagar
Nr. Amrapali Under Bridge
Raiya Road, Rajkot.
Ph.No-(0281)2440478

3 - Vaishali Nagar
Nr. Amrapali Under Bridge
Raiya Road, Rajkot.
Ph. No-(0281)2471645

Command Name	Definition	Syntax & Ex	Options
Output Redirection	The '>' symbol is used for output (STDOUT) redirection.	ls -al > listings	ls -al is re-directed to file "listings" instead of your screen. ">>" appends output to an existing file.
Input redirection	The '<' symbol is used for input(STDIN) redirection You can type the contents of the email using the standard device keyboard. But if you want to attach a File to email you can use the input re-direction operator in the following format.	Mail -s "Subject" to-address < Filename	
Piping in Unix	Pipe is used to combine two or more commands, and in this, the output of one command acts as input to another command, and this command's output may act as input to the next command and so on. It can also be visualized as a temporary connection between two or more commands/ programs/ processes.	command_1 command_2 command_3 command_N Listing all files and directories and give it as input to more command.	

SHREE H. N. SHUKLA COLLEGE OF IT & MGMT.



(Affiliated to Saurashtra University & GTU)

2 - Vaishali Nagar
Nr. Amrapali Under Bridge
Raiya Road, Rajkot.
Ph.No-(0281)2440478

3 - Vaishali Nagar
Nr. Amrapali Under Bridge
Raiya Road, Rajkot.
Ph. No-(0281)2471645

Finding pattern in file

Command Name	Definition	Syntax & Ex	Options
grep	The <code>grep</code> filter searches a file for a particular pattern of characters, and displays all lines that contain that pattern. The pattern that is searched in the file is referred to as the regular expression (<code>grep</code> stands for globally search for regular expression and print out).	grep [options] pattern [files] Ex: \$grep -i "UNix" geekfile.txt	-c : This prints only a count of the lines that match a pattern -h : Display the matched lines, but do not display the filenames. -i : Ignores, case for matching -l : Displays list of a filenames only. -n : Display the matched lines and their line numbers. -v : This prints out all the lines that do not matches the pattern
fgrep	The <code>fgrep</code> filter is used to search for the fixed-character strings in a file. There can be multiple files also to be searched. This command is useful when you need to search for strings which contain lots of regular expression	fgrep [options] [-e pattern_list] [pattern] [file] \$fgrep -c "usin.g" para	-c : It is used to print only a count of the lines which contain the pattern. -h : Used to display the matched lines. -i : During comparisons, it will ignore upper/lower case distinction. -l : Used to print the names of files with matching lines

SHREE H. N. SHUKLA COLLEGE OF IT & MGMT.



(Affiliated to Saurashtra University & GTU)

2 - Vaishali Nagar
Nr. Amrapali Under Bridge
Raiya Road, Rajkot.
Ph.No–(0281)2440478

3 - Vaishali Nagar
Nr. Amrapali Under Bridge
Raiya Road, Rajkot.
Ph. No–(0281)2471645

	metacharacters, such as “^”, “\$”, etc.		once, separated by new-lines. It will not repeat the names of files when the pattern is found more than once. -n : It is used precede each line by its line number in the file (first line is 1).
egrep	egrep is a pattern searching command which belongs to the family of grep functions. It works the same way as grep -E does. It treats the pattern as an extended regular expression and prints out the lines that match the pattern. If there are several files with the matching pattern, it also displays the file names for each line.	egrep [options] 'PATTERN' files	-c : Used to counts and prints the number of lines that matched the pattern and not the lines. -v : It prints the lines that does not match with the pattern. -i : Ignore the case of the pattern while matching. -l : Prints only the names of the files that matched. It does not mention the matching line numbers or any other information. -L : Prints only the names of the files that did not have the pattern.

SHREE H. N. SHUKLA COLLEGE OF IT & MGMT.



(Affiliated to Saurashtra University & GTU)

2 - Vaishali Nagar
Nr. Amrapali Under Bridge
Raiya Road, Rajkot.
Ph.No–(0281)2440478

3 - Vaishali Nagar
Nr. Amrapali Under Bridge
Raiya Road, Rajkot.
Ph. No–(0281)2471645

Working with columns and fields

cut

- Purpose : cut command is basically used for extracting the vertical columns or set of characters from either standard input from one or more files. The cut command looks for the character positions as well as fixed aligned columns. For specifying the character position we use the **option –c**.

Example :

Roll No.	Student Name	Email id
101	ABC	abc@d.com
102	DEF	def@b.com

\$ cut -c 1-4 file4

- It will extract only the roll numbers from the data file file4.
- Now if the character length of the column is not fixed, it may be more than the character range specified in **–c option** as in the case of student email id or student name.
- We can use
- **-f option**

cut -f [column number] filename

- Here, if we need only the student name from file4 then we need the second column So we can use **cut -f 2 file4**. Here 2 specifies the second column.
- Example :
- **\$ cut -f 2 file4**
- ABC
- DEF

Paste

- Paste command combines the lines together. These lines can be from multiple files. If the input is from standard input then (-) hyphen sign is used. It combines the files vertically.

SHREE H. N. SHUKLA COLLEGE OF IT & MGMT.



(Affiliated to Saurashtra University & GTU)

2 - Vaishali Nagar
Nr. Amrapali Under Bridge
Raiya Road, Rajkot.
Ph.No-(0281)2440478

3 - Vaishali Nagar
Nr. Amrapali Under Bridge
Raiya Road, Rajkot.
Ph. No-(0281)2471645

Example :

```
$ cat file1.txt
```

```
1 ABC  
2 DEF  
3 EFG
```

```
$cat file2.txt
```

```
1 101  
2 102  
3 103
```

```
$ paste file1 file3
```

```
1 ABC 1 101  
2 DEF 2 102  
3 EFG 3 103
```

- It combines the first line of the first file with the first line of the second file and displays the combination on the standard output. The two lines are separated by a tab. Paste command treats each line as a column.

Options :

- **-d delimiter_list** : It consecutively use the characters in delimiter_list instead of tab to separate merged lines.

Example :

```
$ paste -d '%_' file1 file3
```

```
1 ABC%1 101  
2 DEF%2 102  
3 EFG%3 103
```

join

- Join command joins two files, here files are joined on common column. In join command the common column (key field) should exist in both files and the data must

SHREE H. N. SHUKLA COLLEGE OF IT & MGMT.



(Affiliated to Saurashtra University & GTU)

2 - Vaishali Nagar
Nr. Amrapali Under Bridge
Raiya Road, Rajkot.
Ph.No-(0281)2440478

3 - Vaishali Nagar
Nr. Amrapali Under Bridge
Raiya Road, Rajkot.
Ph. No-(0281)2471645

be sorted on the common column in same order. The default join field is first, delimited by whitespace.

- The join command reads the first line of the first file, then reads lines from the second file until the contents in the key field of the second file match or exceed the contents in the key field of the first file.

Syntax :

- **join [option] file1 file2**

Example :

- Suppose we have two files of the student data, one file contains roll number and s and another contain roll number and name then output will be :

\$ join file1 file2

```
1 ABC 101
2 DEF 102
3 EFG 103
```

If we have a file, myfile1.txt, whose contents are :

```
1 India
2 US
3 Ireland
4 UK
5 Canada
```

And another file, myfile2.txt, whose contents are :

```
1 New Delhi
2 Washington
3 Dublin
4 London
5 Toronto
```

- The common fields are the fields which begin with the same number. We can join the contents using the following command :

\$ join myfile1.txt myfile2.txt

Output :

```
1 India New Delhi
2 US Washington
```

SHREE H. N. SHUKLA COLLEGE OF IT & MGMT.



(Affiliated to Saurashtra University & GTU)

2 - Vaishali Nagar
Nr. Amrapali Under Bridge
Raiya Road, Rajkot.
Ph.No–(0281)2440478

3 - Vaishali Nagar
Nr. Amrapali Under Bridge
Raiya Road, Rajkot.
Ph. No–(0281)2471645

- 3 Ireland Dublin
- 4 UK London
- 5 Canada Toronto

- If we wanted to create a new file with the joined contents, we could use the following command :

\$ join myfile1.txt myfile2.txt > newfile.txt

- It directs the output into the new file named newfile.txt.

Commands for Sorting

Command Name	Definition	Syntax & Ex	Options
sort	The sort command is used for arranging the data in ascending or descending order.	\$ sort file1.txt \$ sort -r file1 103 102	- r : sorts the file in reverse order - c : Checks if the file is sorted - n : Numeric sort
uniq	Uniq command selects one non repeated line and removes other duplicate lines from the output. It needs a sorted file as an input.		- u : Displays the non-duplicate lines and displays only the uniq lines from the file. -d : display only the duplicate line. -c : count the number of duplicate lines in the file. It needs sorted file as an input.

SHREE H. N. SHUKLA COLLEGE OF IT & MGMT.



(Affiliated to Saurashtra University & GTU)

2 - Vaishali Nagar
Nr. Amrapali Under Bridge
Raiya Road, Rajkot.
Ph.No-(0281)2440478

3 - Vaishali Nagar
Nr. Amrapali Under Bridge
Raiya Road, Rajkot.
Ph. No-(0281)2471645

Comparing files

Command Name	Definition	Syntax & Ex	Options
cmp	This command compares two files byte by byte, that means the first byte of first file with the first byte of the second file, if both are same it checks the next byte, wherever the bytes are not same it displays the message that first file and second file differ : byte number, line number as shown below.	\$ cmp file1 file2 file1 file2 differ : byte 13, line1	
comm	This command is useful to compare two sorted files line by line. The output of comm command consists of three columns, the first column is the lines which are unique to the first file. The second column displays the lines which are unique to the second file and the third	\$ comm [option] file1 file2	-1 lines unique to file1 -2 lines unique to file2 -3 lines that appear in both files

SHREE H. N. SHUKLA COLLEGE OF IT & MGMT.



(Affiliated to Saurashtra University & GTU)

2 - Vaishali Nagar
Nr. Amrapali Under Bridge
Raiya Road, Rajkot.
Ph.No-(0281)2440478

3 - Vaishali Nagar
Nr. Amrapali Under Bridge
Raiya Road, Rajkot.
Ph. No-(0281)2471645

	column displays the lines which are common between both the files.		
diff	This command finds difference between two files. diff command compares file1 and file2. If both file1 and file2 are directories, diff command compares corresponding files in both directories in alphabetical order.	diff file1 file2	<p>-a Treat all files as text and compare them line by line.</p> <p>-b Ignore changes in amount of white space.</p> <p>-i Ignore changes in case. Consider upper and lower case letters same.</p>

Changing information in files

Command Name	Definition	Syntax & Ex	Options
tr	This command is useful for changing the case from upper to lower. Translate and delete characters from standard input, writing to standard output.	tr [option] 'set1' 'set2' \$cat file tr "[a-z]" "[A-Z]"	<p>-d : delete characters in the first set from the output.</p> <p>-s : replaces repeated characters listed in the set1 with single occurrence</p>
sed	sed is a Stream Editor used for modifying the files in unix (or linux). Whenever you want	\$ sed 's/unix/linux/' file.txt Here the "s" specifies the	

SHREE H. N. SHUKLA COLLEGE OF IT & MGMT.



(Affiliated to Saurashtra University & GTU)

2 - Vaishali Nagar
Nr. Amrapali Under Bridge
Raiya Road, Rajkot.
Ph.No–(0281)2440478

3 - Vaishali Nagar
Nr. Amrapali Under Bridge
Raiya Road, Rajkot.
Ph. No–(0281)2471645

	<p>to make changes to the file automatically, Consider the below text file as an input.</p> <p>sed command is mostly used to replace the text in a file. The below simple sed command replaces the word "unix" with "linux" in the file.</p>	<p>substitution operation. The "/" are delimiters. The "unix" is the search pattern and the "linux" is the replacement string.</p> <p>By default, the sed command replaces the first occurrence of the pattern in each line and it won't replace the second, third...occurrence in the line.</p>	
--	--	--	--

Examining File Contents

Command Name	Definition	Syntax & Ex	Options
od	od command in Linux is used to output the contents of a file in different formats with the octal format being the default.	od [OPTION]... [FILE]... \$ od -b input	Display contents of file in octal format using -b option

Tools for mathematical calculations

Command Name	Definition	Syntax & Ex	Options
bc	bc is a unix command which stands for bench calclutor. bc	bc [options] [file...] Example : \$ x=20 \$ y=10	

SHREE H. N. SHUKLA COLLEGE OF IT & MGMT.



(Affiliated to Saurashtra University & GTU)

2 - Vaishali Nagar
Nr. Amrapali Under Bridge
Raiya Road, Rajkot.
Ph.No–(0281)2440478

3 - Vaishali Nagar
Nr. Amrapali Under Bridge
Raiya Road, Rajkot.
Ph. No–(0281)2471645

	command is used to do some simple arithmetic.	\$ echo \$x+\$y bc 30	
factor	The factor command in Linux is used to print the prime factors of the given numbers, either given from command line or read from standard input.	factor [NUMBER] Example : \$ factor 100	

Monitoring input and output

Command Name	Definition	Syntax & Ex	Options
tee	Reads from standard input, and writes to standard output and to files. tee copies data from standard input to each FILE, and also to standard output.	tee [OPTION]... [FILE]... ls -l *.txt wc -l tee count.txt	-a Option : It basically do not overwrite the file but append to the given file. Suppose we have file1.txt –help Option : It gives the help message and exit. –version Option : It gives the version information and exit.
script	script makes a typescript of everything printed on your terminal. It	script [-a] [file]	-a, –append: This option is used when we want to append the output, retaining

SHREE H. N. SHUKLA COLLEGE OF IT & MGMT.



(Affiliated to Saurashtra University & GTU)

2 - Vaishali Nagar
Nr. Amrapali Under Bridge
Raiya Road, Rajkot.
Ph.No–(0281)2440478

3 - Vaishali Nagar
Nr. Amrapali Under Bridge
Raiya Road, Rajkot.
Ph. No–(0281)2471645

is useful for users who need a hardcopy record of an interactive session as proof of work done.

the prior content of the file. The multiple contents get separated by adding a line that states the date and time of the script started.

-c, –command: This option is used when we want to run a particular command rather than interactive shell and get terminal information in the file given as argument or typescript by default. The script will automatically exit after successful execution.

-q, –quiet: This option does not display the notification stating that the script has started and quietly execute and exit the *script* command.

SHREE H. N. SHUKLA COLLEGE OF IT & MGMT.



(Affiliated to Saurashtra University & GTU)

2 - Vaishali Nagar
Nr. Amrapali Under Bridge
Raiya Road, Rajkot.
Ph.No-(0281)2440478

3 - Vaishali Nagar
Nr. Amrapali Under Bridge
Raiya Road, Rajkot.
Ph. No-(0281)2471645

Tools for displaying date and time

Command Name	Definition	Syntax & Ex	Options
Cal	To display a calendar A single parameter specifies the 4 digit year (1 - 9999) to be displayed. Two parameters denote the Month (1 - 12) and Year (1 - 9999). If arguments are not specified, the current month is displayed. A year starts on 01 Jan.	cal [-m]y] [[month] year]	-m Display monday as the first day of the week. -j Display julian dates (days one-based, numbered from January 1). -y Display a calendar for the current year.
date	The date command is used to print out, or change the value of, the system's time and date information.	date [OPTION]... [+FORMAT] \$ date "+DATE: %m/%d/%y%nTIME: %H:%M:%S"	-d, --date=STRING display time described by string STRING, as opposed to the default, which is 'now'

Communications

Command Name	Definition	Syntax & Ex	Options
telnet	The telnet command is used to communicate with another host using the TELNET protocol. If telnet is	Syntax : telnet [host [port]] Example : \$ telnet	

SHREE H. N. SHUKLA COLLEGE OF IT & MGMT.



(Affiliated to Saurashtra University & GTU)

2 - Vaishali Nagar
Nr. Amrapali Under Bridge
Raiya Road, Rajkot.
Ph.No–(0281)2440478

3 - Vaishali Nagar
Nr. Amrapali Under Bridge
Raiya Road, Rajkot.
Ph. No–(0281)2471645

	invoked without the host argument, it enters command mode, indicated by its prompt (telnet>).		
wall	wall displays the contents of file or, by default, its <u>standard input</u> , on the <u>terminals</u> of all currently <u>logged in</u> users.	wall [-n] [file] \$ wall message.txt	-n, --nobanner Supress banner
motd	To display message of the day at login time. The contents of /etc/motd are displayed after a successful login but just before it executes the login shell. The motd stands for “message of the day”.		
write	The write utility allows you to communicate with other users, by copying lines from your terminal to theirs.	Example : \$write hope	user The user to write to.

SHREE H. N. SHUKLA COLLEGE OF IT & MGMT.



(Affiliated to Saurashtra University & GTU)

2 - Vaishali Nagar
 Nr. Amrapali Under Bridge
 Raiya Road, Rajkot.
 Ph.No-(0281)2440478

3 - Vaishali Nagar
 Nr. Amrapali Under Bridge
 Raiya Road, Rajkot.
 Ph. No-(0281)2471645

	<p>When you run the write command, the user you are writing to gets a message of the format: Message from yourname@yourhost on yourtty at hh:mm ... Any further lines you enter will be copied to the specified user's terminal. If the other user wants to reply, they must run write as well.</p>		
mail	<p>Being able to send emails from command-line from a server is quite useful when you need to generate emails programmatically from shell scripts or web applications.</p>	<p>Syntax : \$mail [option] [message] [mailid] Example : \$ mail -s "Hello World" someone@example.com</p>	
finger	<p>finger looks up and displays information about system users. It is known as user information look up program.</p>	<p>Syntax : finger [option] [user ...] Example : finger -s myuser</p>	

SHREE H. N. SHUKLA COLLEGE OF IT & MGMT.



(Affiliated to Saurashtra University & GTU)

2 - Vaishali Nagar
 Nr. Amrapali Under Bridge
 Raiya Road, Rajkot.
 Ph.No-(0281)2440478

3 - Vaishali Nagar
 Nr. Amrapali Under Bridge
 Raiya Road, Rajkot.
 Ph. No-(0281)2471645

Process related commands

Command Name	Definition	Syntax & Ex	Options
ps	On every <u>UNIX</u> -like operating system, the process status command (ps) displays information about active processes.	Syntax : ps Example : \$ ps	
nice	nice command affects <u>process</u> scheduling. A process with a lower niceness value is given higher priority. A process with a higher niceness value is given a lower priority.	Syntax : nice Example : \$nice	
kill	On Unix-like operating systems, the kill command sends a signal to a process. If you don't specify which signal to send, by default the TERM signal is sent, which terminates the process.	Syntax : kill pid Example : \$kill -9	
at and batch	The at and batch command schedules a command to be run once at a	Example : \$ at 9:30 PM Tue \$ batch	

SHREE H. N. SHUKLA COLLEGE OF IT & MGMT.



(Affiliated to Saurashtra University & GTU)

2 - Vaishali Nagar
Nr. Amrapali Under Bridge
Raiya Road, Rajkot.
Ph.No–(0281)2440478

3 - Vaishali Nagar
Nr. Amrapali Under Bridge
Raiya Road, Rajkot.
Ph. No–(0281)2471645

	particular time. This can be any command that you normally have permission to run. You start by running the at command at the command line, passing it the scheduled time as the option. batch does not accepts any parameters		
cron and crontab	Linux crontab command. On Unix-like operating systems, the crontab command opens the cron table for editing. The cron table is the list of tasks scheduled to run at regular time intervals on the system.	syntax crontab [-u user] file Example : crontab –l	-l Display the current crontab. -r Remove the current crontab.
wait	wait is a built-in <u>shell</u> command which waits for a given <u>process</u> to complete, and returns its exit status. wait waits for the process identified by process ID pid (or the job specified by	Syntax : wait [pid] Example : wait 2017	

SHREE H. N. SHUKLA COLLEGE OF IT & MGMT.



(Affiliated to Saurashtra University & GTU)

2 - Vaishali Nagar
 Nr. Amrapali Under Bridge
 Raiya Road, Rajkot.
 Ph.No–(0281)2440478

3 - Vaishali Nagar
 Nr. Amrapali Under Bridge
 Raiya Road, Rajkot.
 Ph. No–(0281)2471645

	job ID jobid), and reports its termination status.		
Sleep	The sleep command pauses for an amount of time defined by NUMBER. SUFFIX may be "s" for seconds (the default), "m" for minutes, "h" for hours, or "d" for days.	<p><i>syntax</i></p> <p>sleep NUMBER[SUFFIX]...</p> <p><i>example : \$ sleep 10</i></p>	

Mount/Unmount commands

Command Name	Definition	Syntax & Ex	Options
mount and unmount	The mount command <u>mounts</u> a <u>storage device</u> or <u>filesystem</u> , making it accessible and attaching it to an existing <u>directory</u> structure. The unmount command "unmounts" a mounted filesystem, informing the system to complete any pending <u>read</u> or <u>write</u> operations, and safely detaching it.	<p><i>Syntax1</i></p> <p>mount [OPTION...] DEVICE_NAME DIRECTORY</p> <p><i>Syntax2</i></p> <p>mount [OPTION...] DEVICE_NAME DIRECTORY</p> <p>Example : \$ mount –t type device dir \$ unmount –t type device dir</p>	Use the -t option to specify the file system type.

SHREE H. N. SHUKLA COLLEGE OF IT & MGMT.



(Affiliated to Saurashtra University & GTU)

2 - Vaishali Nagar
Nr. Amrapali Under Bridge
Raiya Road, Rajkot.
Ph.No–(0281)2440478

3 - Vaishali Nagar
Nr. Amrapali Under Bridge
Raiya Road, Rajkot.
Ph. No–(0281)2471645

UNIT 4(PART 1)

Topic: 1 Explain VI editor in detail

Ans.

Detail:

Introduction to VI editor

- No matter what work you do with the UNIX system, you will eventually write some C programs or shell scripts. You may have to edit some of the system files at times.
- For all this you must learn to use an editor, and UNIX provides a very versatile one VI editor, VI editor is a screen editor, where a portion of the file is displayed on the terminal screen, and the cursor can be moved around the screen to indicate where you want to make changes.
- You can select which part of the file you want to have displayed.
- Screen editors are also called display editors, or visual editors. VI is one of the more popular screen editors that run on the UNIX system.

Invoking VI

- It will put filename into a buffer and display the file on the screen.
- If the file is larger than the screen can display, the screen will act as a window into the file.
- At the beginning of a session, the screen will display the first part of the file.
- If filename does not exist, VI will create it.

Modes in VI editor

- One of the most important aspects to remember about **vi** is that most of the commands fall into one of three modes:

(1) Command mode:

SHREE H. N. SHUKLA COLLEGE OF IT & MGMT.



(Affiliated to Saurashtra University & GTU)

2 - Vaishali Nagar
Nr. Amrapali Under Bridge
Raiya Road, Rajkot.
Ph.No–(0281)2440478

3 - Vaishali Nagar
Nr. Amrapali Under Bridge
Raiya Road, Rajkot.
Ph. No–(0281)2471645

- This is the default mode of VI editor. This mode is used to give some command for navigation, edition and copy or cut.
- This is the base mode of VI editor if user want to switch this mode to **insert or input mode then user has to press i or I or a or A.**
- If user wants to switch execute mode from this mode then user has to **press:**

(2) Input or Insert Mode:

- This mode is used to enter data in VI editor. If user wants to insert some text to the editor then first user has to select this mode.
- **This mode will be selected from command mode pressing I or i or a or A.**

(3) Execute Mode:

- This mode is used to save or quit from VI editor. Whatever the changes user has done in file using VI editor if user wants to save, find any particular string then using this mode user can save or find the string and also whenever user wants to quit from the VI editor this mode will supports user to quit from the VI editor.
- **To switch to this mode user has to press: or / on command mode**

Switching mode in VI

- While you start VI editor at that time you will be at vi mode that will ready to accept defined command on that particular key but not any input.
- If you want to input text into the file you will have to go to input mode for that you will have to **press “i”.**
- If you will press **“i”** at VI mode you will be at input mode here you can input any data into the file from this mode if you want to switch to vi mode then you will have to press **“Esc”** key.
- If you will press **“Esc”** key at input mode you will be able to switch to vi mode.
- If you want to switch to command mode from the VI mode then you will have to press **“:” or “/”** that will support you to switch you from VI mode to command mode.
- If you want to switch to command mode from the input mode then you will have to first come to the VI mode then you will be able to switch to command mode.
- To switch from input mode to command mode then you first will have to press **“Esc”** key and then after you will have to press **“:” or “/”** key that will support you to switch from input mode to command mode via VI mode.

SHREE H. N. SHUKLA COLLEGE OF IT & MGMT.



(Affiliated to Saurashtra University & GTU)

2 - Vaishali Nagar
Nr. Amrapali Under Bridge
Raiya Road, Rajkot.
Ph.No–(0281)2440478

3 - Vaishali Nagar
Nr. Amrapali Under Bridge
Raiya Road, Rajkot.
Ph. No–(0281)2471645

Cursor movement in VI editor

- Whatever the command you are giving that will work on VI mode only.
- To move around in the file, use the arrow keys: the up arrow will move the cursor up one line, the down arrow down one line.
- The right arrow will cause the cursor to move one position to the right.
- From the end of a line, it will go to the beginning of the next line.
- For terminals with no functional arrow keys, four keys will move the cursor around:

h	left arrow
j	down arrow
k	up arrow
l	right arrow

Screen control commands

- Whatever the command you are giving that will work on **vi** mode only.

ctrl + f	This will move the user forward one screen in the file.
ctrl+b	This will move the user backward one screen in the file.
G	This will move the cursor to the end of the file. Note, again that vi, like any other UNIX utility, is always case sensitive.
Num	This will bring the cursor to line defined line number.

Entering, Editing, Copying data into vi editor

- Whatever the command you are giving that will work on vi mode only.

X	That will delete on character.
Dd	That will delete lines beginning at the current line.
Yy	That will copy lines beginning at the current line.

SHREE H. N. SHUKLA COLLEGE OF IT & MGMT.



(Affiliated to Saurashtra University & GTU)

2 - Vaishali Nagar
Nr. Amrapali Under Bridge
Raiya Road, Rajkot.
Ph.No–(0281)2440478

3 - Vaishali Nagar
Nr. Amrapali Under Bridge
Raiya Road, Rajkot.
Ph. No–(0281)2471645

P	That will paste copied line.
U	This is very useful command. It cancels the effect of the previously executed command.
Q	When in vi, typing will bring the user into command mode. As the : is typed, it will be displayed n the last line of the screen, and vi will wait for a command to be typed. q is such a command. This will exit vi, if no changes have been made since the last write-to-file command :q! will exit, even if the buffer has not been written to the file.
W	Will cause the contents of the buffer to be written to the file :wq will write the buffer to the file, and exit the calling shell.
I	This will support you to switch from VI mode to input mode.
:	This will support you to switch from VI mode to command mode.
Esc	This will support you to switch from input mode to VI mode.
/	This will support you to find any particular pattern from the file.

One word question answer

Question

Answer

1. _____ is the default mode of VI editor. Command Mode
2. _____ mode is used to enter data in VI editor. Input / Insert Mode
3. _____ mode is used to save or quit from VI editor. Execute Mode

Topic :2 introduction of nano editor.

Nano is a user-friendly, simple and WYSIWYG(What You See Is What You Get) text editor, which improves the features and user-friendliness of UW Pico text editor. Unlike vim editor or any other command-line editor, it doesn't have any mode. It has an easy GUI(Graphical User Interface) which allows users to interact directly with the text in spite of switching between the modes as in vim editor.

Installing Nano Text Editor

Nano is generally by default available in many Linux distributions but in case, it is not installed you may install the same using the following commands.

SHREE H. N. SHUKLA COLLEGE OF IT & MGMT.



(Affiliated to Saurashtra University & GTU)

2 - Vaishali Nagar
Nr. Amrapali Under Bridge
Raiya Road, Rajkot.
Ph.No–(0281)2440478

3 - Vaishali Nagar
Nr. Amrapali Under Bridge
Raiya Road, Rajkot.
Ph. No–(0281)2471645

\$sudo apt update

In case of Debian/Ubuntu

\$sudo apt install nano

In case of CentOS/Fedora

\$yum install nano

Working with Nano Text Editor

1. To create and open a new file.

\$nano new_filename

The above command will open a new file with new_filename as shown in the output. In case the file already exists it will open the same and in case the file is not there in the current directory it will create a new one. At the bottom of the window, there is a list of shortcut keys for nano.

2. To save a file

press **Ctrl+o**

It will ask you for the filename. In case, you want to save the changes to a new file or want to create a new file then change the name else keep the name same.

As soon as you will press enter key, then In case, you have changed the name of the file then it will save the file with a new name and if not then it will save the changes to the current file.

3. To cut paste in a file. *Ctrl+o* is used to cut and *Ctrl+u* is used to paste the text.

- *To cut and paste a whole line.* Move to the line which you want to cut then press *Ctrl+k*. Now the line is moved to clipboard, To paste it, go to the position where you want to paste and then press *Ctrl+u*
- *To cut and paste the selected text.* Select the text which you want to cut then press *Ctrl+k*. Now the text is moved to clipboard. To paste it, go to the position where you want to paste and then press *Ctrl+u*.
- **4.** To search a word in a file. *Ctrl+w* is used.

- Press *Ctrl+w*

It will ask for a word to search for.

Enter the word

It will search for the word and will place the cursor in the first letter of the first occurrence of the word.

SHREE H. N. SHUKLA COLLEGE OF IT & MGMT.



(Affiliated to Saurashtra University & GTU)

2 - Vaishali Nagar
Nr. Amrapali Under Bridge
Raiya Road, Rajkot.
Ph.No–(0281)2440478

3 - Vaishali Nagar
Nr. Amrapali Under Bridge
Raiya Road, Rajkot.
Ph. No–(0281)2471645

- 5. To enable spell check in nano. First, install the spell check package.
- \$sudo apt install spell
 - To do spell check first press Ctrl+t
 - Now it will ask you to replace the incorrect words
 - Enter the word to replace with there
 - As soon as you will press the enter key
- It will then ask for the password then enter the password. Then press y and then press enter.

UNIT – 4 (Part-2)

Shell Programming Getting Started with Linux, Linux Booting

Topic: 1 What are Shell keywords?

Ans.

Detail:

- Keyword is a word which is having specific meaning for particular language.
- In programming different words are used like, if, for, while, until, case etc. these words are called shell keywords.

One word question answer

Question

6. What are Shell keywords?

7. Give the name of some shell keywords.

Answer

Word with specific meaning

if, for, while, until, case

SHREE H. N. SHUKLA COLLEGE OF IT & MGMT.



(Affiliated to Saurashtra University & GTU)

2 - Vaishali Nagar
Nr. Amrapali Under Bridge
Raiya Road, Rajkot.
Ph.No–(0281)2440478

3 - Vaishali Nagar
Nr. Amrapali Under Bridge
Raiya Road, Rajkot.
Ph. No–(0281)2471645

Topic: 2 Explain Shell Variables.

Ans.

Detail:

- Variable is the location in the memory which is used to store the data.
- A variable is a character string to which we assign a value.
- The value assigned could be a number, text, filename, device, or any other type of data.
- The name of a variable can contain only letters (a to z or A to Z), numbers (0 to 9) or the underscore character (_).
- The following examples are valid variable names –

_RAM
TOKEN_A
VAR_1
VAR_2

- Following are the examples of invalid variable names –

2_VAR
-VARIABLE
VAR1-VAR2
VAR_A!

→ Defining Variables

Variables are defined as follows –

variable_name=variable_value

- Shell enables you to store any value you want in a variable. For example –

VAR1="Rohit Sharma" VAR2=100

→ Accessing Values

- To access the value stored in a variable, prefix its name with the dollar sign (\$)

```
#!/bin/sh  
NAME="Rohit Sharma"
```

SHREE H. N. SHUKLA COLLEGE OF IT & MGMT.



(Affiliated to Saurashtra University & GTU)

2 - Vaishali Nagar
Nr. Amrapali Under Bridge
Raiya Road, Rajkot.
Ph.No–(0281)2440478

3 - Vaishali Nagar
Nr. Amrapali Under Bridge
Raiya Road, Rajkot.
Ph. No–(0281)2471645

echo \$NAME

- The above script will produce the following value –
Rohit Sharma

One word question answer

Question

1. What is variable?
2. How to define variable?

Answer

Location to store data
variable_name=variable_value

Topic: 3 Explain types of Variables in Linux.

Ans.

Detail:

- There are three types of variables.
1. Shell Variables
 2. System Variables or Environment Variable
 3. Users define variable

1. Shell Variables

- These variables are used to configure the shell.
- The shell provides string valued variables.

Example:

- User=root, which assigns values to the variable user.
- The value of variable is substituted by preceding name with \$.

➤ Other Shell parameters:

- \$* : It is the set of positional parameters as a single string.
- \$@ : It is same as \$* except when enclosed in double quotes.
- \$? : The exit status of the last command executed as a decimal string.

SHREE H. N. SHUKLA COLLEGE OF IT & MGMT.



(Affiliated to Saurashtra University & GTU)

2 - Vaishali Nagar
Nr. Amrapali Under Bridge
Raiya Road, Rajkot.
Ph.No–(0281)2440478

3 - Vaishali Nagar
Nr. Amrapali Under Bridge
Raiya Road, Rajkot.
Ph. No–(0281)2471645

- \$# : The number of positional parameters.
- \$\$: The process number of this shell (in decimal).
- \$! : The process number of the last process runs in the background.

2. System Variables

- These variables are used to configure the environment during the boot sequence or after user login, so they are also known as environment variables.
- The shell has two prompts stored in PS1 and PS2.

PS1: It is the primary prompt string like \$ or %. The shell uses the primary prompt when the command is expected by the shell. For changing the value of this prompt, we can use **PS1= '@'**.

As soon as it is set the new prompt is displayed. It can be restored back to \$ prompt as **PS1="\$"**.

PS2: It is the secondary prompt; it is used when the command entered on the first line was not able to be completed. The default prompt is >.

PATH: Searches the path for commands. If \$PATH is not set then the current directory, /bin and /usr/bin are searched by default. Otherwise \$PATH consists of directory names separated by:

For Example: **PATH=:/usr/Bhavik/bin:/bin:/usr/bin**

HOME: It is path name for the home directory. When the user logs in the system, unix normally places the user in home directory or login directory and is the path stored in variable HOME.

The change the default argument for the cd command.

For Example: **cd /usr/Bhavik/bin**

LOGNAME: It contains login name which is stored in the passwd file. This variable shows your username only while Who am I also displays the user name with the terminal type and login name.

MAIL: It displays the absolute path name of user's mailbox and determines where all incoming mail addressed to the user is to be stored. This variable is typically set in the file .profile, in the user's login directory.

For Example: **MAIL=/var/spool/mail/root**

SHREE H. N. SHUKLA COLLEGE OF IT & MGMT.



(Affiliated to Saurashtra University & GTU)

2 - Vaishali Nagar
Nr. Amrapali Under Bridge
Raiya Road, Rajkot.
Ph.No–(0281)2440478

3 - Vaishali Nagar
Nr. Amrapali Under Bridge
Raiya Road, Rajkot.
Ph. No–(0281)2471645

IFS: This variable contains internal field separators. These are the characters that separate the parameters and commands. These separators include space, tab and newline. Default separator is space.

SHELL: This variable contains the pathname of login shell. Various shells available in unix system include korn shell, bash shell or c shell. User can select any one from them.

TERM: It indicates the Terminal type being used. The value of this variable can be utilised by VI command. The VI editor makes the use of the control file in the directory /usr/lib/terminfo.

MAILCHECK: It contains Interval between tests for new email. The default is 600 seconds. When the user logs in, shell checks mail file to determine if there is new mail. If mail is there, it display “You have a mail”.

3. User defined variables

- The variable which is created by the user is known as user defined variables.

 1. The variable name should not be the same as one of the predefined variables.
 2. The name of the variable must start with an alphabet or underscore.
 3. Unix is case sensitive, so SUM and sum are treated as different variables.

➔ set, unset, and echo command with variables

- You can use set command to set any variable.
- You can use unset command to unset/remove any variable.
- You can use echo command to print the value of any variable.

One word question answer

Question	Answer
1. What is shell variable?	Used to configure shell
2. What is system variable?	Used to configure system environment
3. How many prompts shell has?	PS1 & PS2

SHREE H. N. SHUKLA COLLEGE OF IT & MGMT.



(Affiliated to Saurashtra University & GTU)

2 - Vaishali Nagar
Nr. Amrapali Under Bridge
Raiya Road, Rajkot.
Ph.No–(0281)2440478

3 - Vaishali Nagar
Nr. Amrapali Under Bridge
Raiya Road, Rajkot.
Ph. No–(0281)2471645

Topic: 4 Explain Positional parameters.

Ans.

Detail:

- A **positional parameter** is a variable within a shell program; its value is set from an argument specified on the command line that invokes the program.
- **Positional parameters** are numbered and are referred to with a preceding ``\$``: \$1, \$2, \$3, and so on.
- **Example:**

```
$sh filename.sh first second third fourth fifth sixth seventh eighth ninth
$0 $1 $2 $3 $4 $5 $6 $7 $8
$9
```

- Arguments are user supplied data that follow the file name on the command line and are input to the shell script.
- Positional Parameters are predefined memory variables in the shell scripts.
- There are nine positional parameters \$1, \$2..... \$9 that are used to store the user arguments.
- The file name is stores in \$0.
- When script is executed the shell puts the first argument in first positional parameter \$1, second argument in second positional parameter \$2 and so on.

One word question answer

Question

Answer

1. How many positional parameters are available? 9
2. Which positional parameter store file name? \$0

SHREE H. N. SHUKLA COLLEGE OF IT & MGMT.



(Affiliated to Saurashtra University & GTU)

2 - Vaishali Nagar
Nr. Amrapali Under Bridge
Raiya Road, Rajkot.
Ph.No-(0281)2440478

3 - Vaishali Nagar
Nr. Amrapali Under Bridge
Raiya Road, Rajkot.
Ph. No-(0281)2471645

Topic: 5 Interactive Shell scripts

The read command is a shell built-in command for reading data from a file or keyboard.

The read command receives the input from the keyboard or a file until it receives a newline character. Then, it converts the newline character into a null character:

1. Read a value and store it in the variable, shown as follows:

2. **read variable**

3. **echo \$variable**

This will receive text from the keyboard. The received text will be stored in the variable.

4. Command read with prompt. Whenever we need to display the prompt with certain text, we use the `-p` option. The option `-p` displays the text that is placed after `-p` on the screen:

5. `#!/bin/bash`

6. `# following line will print "Enter value: " and then read data`

7. `# The received text will be stored in variable value`

```
read -p "Enter value : " value
```

Output:

Enter value : abcd

8. If the variable name is not supplied next to the read command, then the received data or text will be stored in a special built-in variable called `REPLY`. Let's write...

Topic: 6 Explain Decision statements in Linux.

Ans.

Detail:

SHREE H. N. SHUKLA COLLEGE OF IT & MGMT.



(Affiliated to Saurashtra University & GTU)

2 - Vaishali Nagar
Nr. Amrapali Under Bridge
Raiya Road, Rajkot.
Ph.No-(0281)2440478

3 - Vaishali Nagar
Nr. Amrapali Under Bridge
Raiya Road, Rajkot.
Ph. No-(0281)2471645

- While writing a shell script, there may be a situation when you need to adopt one path out of the given two paths. So, you need to make use of **conditional statements** that allow your program to make correct decisions and perform the right actions.
- Unix Shell supports **conditional statements** which are used to perform different actions based on different conditions.
- Unix shell provides decision making using if then else and case structure.

If – then – fi

Syntax:

```
If [condition]
then
execute command if condition is true
...
fi
```

Example:

```
NAME="Rohit"
if [ $NAME = "Rohit" ]
then
echo "True - my name is Rohit"
fi
```

If – else – fi

- If given condition is true, then command1 is executed else command2 is executed.

Syntax:

```
If [condition]
then
    execute command1 if condition is true
else
    execute command2 if condition is false
fi
```

Example:

```
NAME="Virat"
```

SHREE H. N. SHUKLA COLLEGE OF IT & MGMT.



(Affiliated to Saurashtra University & GTU)

2 - Vaishali Nagar
Nr. Amrapali Under Bridge
Raiya Road, Rajkot.
Ph.No-(0281)2440478

3 - Vaishali Nagar
Nr. Amrapali Under Bridge
Raiya Road, Rajkot.
Ph. No-(0281)2471645

```
if [ $NAME = "Rohit" ]
then
  echo "True - my name is Rohit"
else
  echo "False"
  echo "My name is $NAME"
fi
```

if...elif...else...fi

- The if...elif...fi statement is the one level advance form of control statement that allows Shell to make correct decision out of several conditions.

Syntax:

```
if [ condition 1 ]
then
  Statement to be executed if condition 1 is true
elif [ condition 2 ]
then
  Statement to be executed if condition 2 is true
else
  Statement to be executed if no expression is true
fi
```

Example:

```
NAME="Rohit"
if [ $NAME = "Virat" ]
then
  echo "Virat Kohli"
elif [ $NAME = "Rohit" ]
then
  echo "Rohit Sharma"
else
  echo "This is Dhoni"
fi
```

SHREE H. N. SHUKLA COLLEGE OF IT & MGMT.



(Affiliated to Saurashtra University & GTU)

2 - Vaishali Nagar
Nr. Amrapali Under Bridge
Raiya Road, Rajkot.
Ph.No-(0281)2440478

3 - Vaishali Nagar
Nr. Amrapali Under Bridge
Raiya Road, Rajkot.
Ph. No-(0281)2471645

The case...esac Statement

- Unix Shell supports case...esac statement which handles exactly this situation, and it does so more efficiently than repeated if...elif statements.
- There is only one form of case...esac statement

Syntax:

```
case "$variable" in
"$condition1" )
command...
;;
"$condition2" )
command...
;;
esac
```

Example:

```
mycase=1
case $mycase in
1) echo "You selected unix";;
2) echo "You selected php";;
3) echo "You selected java";;
4) echo "You selected c++";;
5) exit
esac
```

One word question answer

Question

Answer

- | | |
|---|-----------|
| 1. How many conditional statements are in Unix? | If & case |
| 2. How can we end if condition statement? | Fi |
| 3. How can we end case condition statement? | esac |

SHREE H. N. SHUKLA COLLEGE OF IT & MGMT.



(Affiliated to Saurashtra University & GTU)

2 - Vaishali Nagar
Nr. Amrapali Under Bridge
Raiya Road, Rajkot.
Ph.No-(0281)2440478

3 - Vaishali Nagar
Nr. Amrapali Under Bridge
Raiya Road, Rajkot.
Ph. No-(0281)2471645

Topic: 7 Explain test command in Linux.

Ans.

Detail:

- The test command is used to check file types and compare values. Test is used in conditional execution.

Syntax:

test condition

OR

test condition && true-command

OR

test condition || false-command

OR

test condition && true-command || false-command

Example :

- Type the following command at a shell prompt (is 5 greater than 2?):

```
test 5 -gt 2 && echo "Yes"
```

```
test 1 -lt 2 && echo "Yes"
```

Sample Output:

Yes

Yes

SHREE H. N. SHUKLA COLLEGE OF IT & MGMT.



(Affiliated to Saurashtra University & GTU)

2 - Vaishali Nagar
Nr. Amrapali Under Bridge
Raiya Road, Rajkot.
Ph.No-(0281)2440478

3 - Vaishali Nagar
Nr. Amrapali Under Bridge
Raiya Road, Rajkot.
Ph. No-(0281)2471645

One word question answer

Question

1. The test command is used to _____.

Answer

check file types and compare values

Topic: 8 Explain logical operators in Linux.

Ans.

Detail:

- **Logical Operators:** They are also known as Boolean operators.
- These are used to perform logical operations.
- They are of 3 types:
 - **Logical AND (&& / -a):** This is a binary operator, which returns true if both the operands are true otherwise returns false.
 - **Logical OR (|| / -o):** This is a binary operator, which returns true if either of the operand is true or both the operands are true and returns false if none of them is false.
 - **Not Equal to (!):** This is a unary operator which returns true if the operand is false and returns false if the operand is true.

Example:

```
# take a number from the user
echo "Enter a number: "
read a

# check
if [ `expr $a % 2` == 0 -a $a -gt 10 ]
then
echo "$a is even and greater than 10."
else
echo "$a failed the test."
fi
```

SHREE H. N. SHUKLA COLLEGE OF IT & MGMT.



(Affiliated to Saurashtra University & GTU)

2 - Vaishali Nagar
Nr. Amrapali Under Bridge
Raiya Road, Rajkot.
Ph.No–(0281)2440478

3 - Vaishali Nagar
Nr. Amrapali Under Bridge
Raiya Road, Rajkot.
Ph. No–(0281)2471645

One word question answer

Question

Answer

1. Logical Operators are also known as ____ . Boolean operators
2. How many types of logical operators available? 3 types

Topic: 9 Explain looping structure in Linux.

Ans.

Detail:

- There is total 2 looping statements which can be used in bash programming

1. **while statement**
2. **for statement**

- To alter the flow of loop statements, two commands are used they are,

1. **break**
2. **continue**

- Their descriptions and syntax are as follows:

➔ while statement

- Here command is evaluated and based on the result loop will executed, if command raise to false then loop will be terminated.

Syntax:

```
while command  
do  
Statement to be executed  
done
```

Example:

```
a=0
```

SHREE H. N. SHUKLA COLLEGE OF IT & MGMT.



(Affiliated to Saurashtra University & GTU)

2 - Vaishali Nagar
Nr. Amrapali Under Bridge
Raiya Road, Rajkot.
Ph.No–(0281)2440478

3 - Vaishali Nagar
Nr. Amrapali Under Bridge
Raiya Road, Rajkot.
Ph. No–(0281)2471645

-lt is less than operator

```
#Iterate the loop until a less than 10
while [ $a -lt 10 ]
do
# Print the values
echo $a
```

```
# increment the value
a=`expr $a + 1`
done
```

→ for statement

- The for loop operate on lists of items.
- It repeats a set of commands for every item in a list.
- Here var is the name of a variable and word1 to wordN are sequences of characters separated by spaces (words).
- Each time the for loop executes, the value of the variable var is set to the next word in the list of words, word1 to wordN.

Syntax:

```
for var in word1 word2 ...wordn
do
Statement to be executed
done
```

Example:

```
#Start of for loop
for a in 1 2 3 4 5 6 7 8 9 10
do
# if a is equal to 5 break the loop
if [ $a == 5 ]
then
break
fi
# Print the value
echo "Iteration no $a"
done
```

SHREE H. N. SHUKLA COLLEGE OF IT & MGMT.



(Affiliated to Saurashtra University & GTU)

2 - Vaishali Nagar
Nr. Amrapali Under Bridge
Raiya Road, Rajkot.
Ph.No–(0281)2440478

3 - Vaishali Nagar
Nr. Amrapali Under Bridge
Raiya Road, Rajkot.
Ph. No–(0281)2471645

→ until loop

- As an exit control loop, until loop is available.

Syntax:

```
until [condition]
do
    command1
    command2
done
```

Example:

```
a=10

until [ $a -lt 10 ]
do
echo $a
a=`expr $a + 1`
done
```

→ The break Statement

- The **break** statement is used to terminate the execution of the entire loop, after completing the execution of all the lines of code up to the break statement.
- It then steps down to the code following the end of the loop.

Syntax:

The following **break** statement is used to come out of a loop –

```
break
```

Example:

```
a=0
```

SHREE H. N. SHUKLA COLLEGE OF IT & MGMT.



(Affiliated to Saurashtra University & GTU)

2 - Vaishali Nagar
Nr. Amrapali Under Bridge
Raiya Road, Rajkot.
Ph.No-(0281)2440478

3 - Vaishali Nagar
Nr. Amrapali Under Bridge
Raiya Road, Rajkot.
Ph. No-(0281)2471645

```
while [ $a -lt 10 ]  
do  
echo $a  
if [ $a -eq 5 ]  
then  
break  
fi  
a=`expr $a + 1`  
done
```

→ The continue statement

- The **continue** statement is like the **break** command, except that it causes the current iteration of the loop to exit, rather than the entire loop.
- This statement is useful when an error has occurred, but you want to try to execute the next iteration of the loop.

Syntax:

```
continue
```

Example:

```
NUMS="1 2 3 4 5 6 7"
```

```
for NUM in $NUMS  
do  
Q=`expr $NUM % 2`  
if [ $Q -eq 0 ]  
then  
echo "Number is an even number!!"  
continue  
fi  
echo "Found odd number"  
done
```

SHREE H. N. SHUKLA COLLEGE OF IT & MGMT.



(Affiliated to Saurashtra University & GTU)

2 - Vaishali Nagar
Nr. Amrapali Under Bridge
Raiya Road, Rajkot.
Ph.No–(0281)2440478

3 - Vaishali Nagar
Nr. Amrapali Under Bridge
Raiya Road, Rajkot.
Ph. No–(0281)2471645

One word question answer

Question

1. The **break** statement is used to ____ .
2. How many looping statements available?

Answer

terminate the execution of the entire loop
2

Topic: 10 Explain Arithmetic in shell.

Ans.

Detail:

- Operators are used for manipulating variables and constants in shell programs.
- They are required to perform mathematical operations.

→ Shell Arithmetic Operators

- **Addition:** +
- **Subtraction:** –
- **Multiplication:** *
- **Division:** /
- **Modulus:** %

Each of these operators performs the operation on two integer variables or constants.

For Example, the below program illustrates each of these operations:

```
$ c=`expr $a + $b`  
$ echo "the value of addition=$c"  
$ d=`expr $a - $b`  
$ echo "the value of subtraction=$d"  
$ e=`expr $a \* $b`  
$ echo "the value of multiplication=$e"  
$ f=`expr $a / $b`  
$ echo "the value of division=$f"  
$ g=`echo `expr $a % $b`  
$ echo "the value of modulus=$c"
```

SHREE H. N. SHUKLA COLLEGE OF IT & MGMT.



(Affiliated to Saurashtra University & GTU)

2 - Vaishali Nagar
Nr. Amrapali Under Bridge
Raiya Road, Rajkot.
Ph.No–(0281)2440478

3 - Vaishali Nagar
Nr. Amrapali Under Bridge
Raiya Road, Rajkot.
Ph. No–(0281)2471645

One word question answer

Question

Answer

1. Arithmetic operators are used to _____ perform mathematic calculations

UNIT – 5 (Part-1)

Topic: 1 Give the introduction of Linux history.

Ans.

Detail:

- Linux started in 1991.
- Linux was created by Linus Torvalds. Initially UNIX was available as operating system, but it was used on huge computers with business and universities in 1970.
- Linus had tried to develop one program especially for the PC with an 80386 processor and independent of any operating system.
- He was developing with use of MINIX (MINIX is kind of operating system which is clone of UNIX).

One word question answer

Question

Answer

1. Linux was developed by _____. Linus Torvalds

Topic: 2 Explain GNU and GPL concept.

Ans.

Detail:

SHREE H. N. SHUKLA COLLEGE OF IT & MGMT.



(Affiliated to Saurashtra University & GTU)

2 - Vaishali Nagar
Nr. Amrapali Under Bridge
Raiya Road, Rajkot.
Ph.No–(0281)2440478

3 - Vaishali Nagar
Nr. Amrapali Under Bridge
Raiya Road, Rajkot.
Ph. No–(0281)2471645

- To prepare free UNIX like operating system, Richard Stallman has started a project called GNU General Public License (GPL).
- In 1990 enough software were available to create full operating system then also GNU was not successful.
- The GNU software was distributed for free to anyone who wanted the source code was also available so user can modify the code according to their need.
- GNU and Linux developers worked to integrate GNU components with Linux kernel to make full functional and free operating system.

One word question answer

Question	Answer
1. GPL stands for.	General Public License

Topic: 3 Explain Open source and freeware.

Ans.

Detail:

- Open source means the software code is available with licensed in which the copyright holder provides the rights to study, modify, and redistribute the software to anyone without any cost and with any purpose.
- Freeware means software is available without cost.
- Freeware generally available with some restricted rights.
- There is not proper definition for freeware and open source, but it can be identified in following terms.
- Anyone can join the open-source project, where in freeware a closed development group is developing the software.
- In open-source code is available so new version can be created from the existing software, where in free ware code is private.

SHREE H. N. SHUKLA COLLEGE OF IT & MGMT.



(Affiliated to Saurashtra University & GTU)

2 - Vaishali Nagar
Nr. Amrapali Under Bridge
Raiya Road, Rajkot.
Ph.No–(0281)2440478

3 - Vaishali Nagar
Nr. Amrapali Under Bridge
Raiya Road, Rajkot.
Ph. No–(0281)2471645

One word question answer

Question

1. What is Freeware?
2. Open-source means?

Answer

Software available without cost
Code is available online

Topic: 4 Explain structure & features of Linux.

Ans.

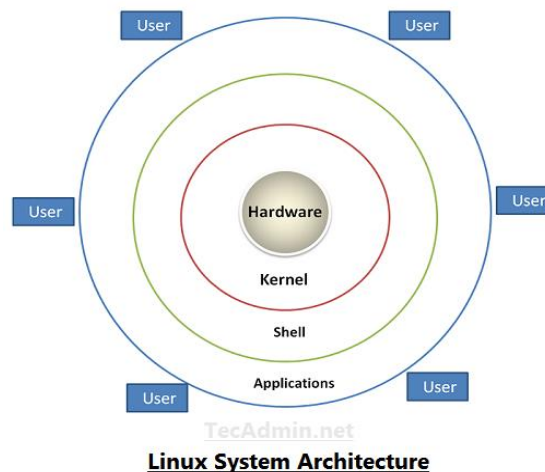

Detail:

Linux Architecture

- The Linux system works basically on 4 layers.
- First view the diagram above, which is showing the architecture of a Linux System.
- **Hardware** – Hardware consists of all physical devices attached to the System. For example: Hard disk drive, RAM, Motherboard, CPU etc.
- **Kernel** – Kernel is the core component for any (Linux) operating system which directly interacts with the hardware.

SHREE H. N. SHUKLA COLLEGE OF IT & MGMT.



(Affiliated to Saurashtra University & GTU)

2 - Vaishali Nagar
Nr. Amrapali Under Bridge
Raiya Road, Rajkot.
Ph.No–(0281)2440478

3 - Vaishali Nagar
Nr. Amrapali Under Bridge
Raiya Road, Rajkot.
Ph. No–(0281)2471645

- **Shell** – Shell is the interface which takes input from Users and sends instructions to the Kernel, Also takes the output from Kernel and send the result back to output shell.
- **Applications** – These are the utility programs which runs on Shell. This can be any application like Your web browser, media player, text editor etc.

Linux Features

- Following are some of the important features of Linux Operating System.
- **Portable** – Portability means software's can works on different types of hardware's in same way. Linux kernel and application programs supports their installation on any kind of hardware platform.
- **Open Source** – Linux source code is freely available, and it is community-based development project. Multiple teams work in collaboration to enhance the capability of Linux operating system and it is continuously evolving.
- **Multi-User** – Linux is a multiuser system means multiple users can access system resources like memory/ ram/ application programs at same time.
- **Multiprogramming** – Linux is a multiprogramming system means multiple applications can run at same time.
- **Hierarchical File System** – Linux provides a standard file structure in which system files/ user files are arranged.
- **Shell** – Linux provides a special interpreter program which can be used to execute commands of the operating system. It can be used to do various types of operations, call application programs etc.
- **Security** – Linux provides user security using authentication features like password protection/ controlled access to specific files/ encryption of data.

One word question answer

Question	Answer
1. What is Kernel?	Core component of OS
2. What is shell?	Interface between user and kernel
3. Write any two features of Linux.	Portable, shell

SHREE H. N. SHUKLA COLLEGE OF IT & MGMT.



(Affiliated to Saurashtra University & GTU)

2 - Vaishali Nagar
Nr. Amrapali Under Bridge
Raiya Road, Rajkot.
Ph.No–(0281)2440478

3 - Vaishali Nagar
Nr. Amrapali Under Bridge
Raiya Road, Rajkot.
Ph. No–(0281)2471645

Topic: 5 Explain installation and configuration of Linux using ubuntu.

Ans.

Detail:

Installation & configuration of Linux

Step 1 – Boot from the CD-ROM

- Installation of UBUNTU requires an installation (bootable) CDROM.
- To make CDROM as first boot device.
- When computer boots up it shows the options to enter the BIOS Setup. Generally, F2 or delete key is pressed to enter the CMOS (BIOS) setup.
- As CDROM is the first boot device, the computer will first boot from the CDROM and it would find the installation CD in the CDROM, and it will ask the user whether computer should be booted using CDROM. Press enters when it is asked to boot from CDROM.
- The installation process starts, and it initially greets the user with a welcome screen. For default installation, press Enter and for server version type server and press enter.

Step 2 – Selection of Language

- Ubuntu supports many languages, and this step in the installation is to select one of the languages from the given list. The default language is English.

Step 3 – Keyboard Layout

- Next, it asks to configure the keyboard layout. Generally, it will be automatically selected, so you can press Enter to ensure the selection. “Test your keyboard” option allows checking whether it is properly configured.

Step 4 – Hardware and Networking Auto Discovery

- Next, Ubuntu configure your hardware and network connection at this stage.
- If there is any network related error then we have option for “Do not configure the network at this time”, so installation will not be interrupted due to this error.

SHREE H. N. SHUKLA COLLEGE OF IT & MGMT.



(Affiliated to Saurashtra University & GTU)

2 - Vaishali Nagar
Nr. Amrapali Under Bridge
Raiya Road, Rajkot.
Ph.No–(0281)2440478

3 - Vaishali Nagar
Nr. Amrapali Under Bridge
Raiya Road, Rajkot.
Ph. No–(0281)2471645

Step 5 – Set a Hostname

- Installation asks for setting a host name for the computer.

Step 6 – Partition the Disk

- Partition has four option:

1. Resize IDEI master (IDE) and use free space
2. Erase entire disk: IDE Master
3. Erase entire disk using LVM
4. Use target continuous free space
5. Manually edit partition table

- The Users can partition the disk manually by providing the appropriate space for the partitions.

Step 7 – Wait during Automated package copying

Step 8 – Set the Time Zone

- Depending on your location, set the time zone for your locality.

Step 9 – Set your Real Name, Username and Password

- To login to the system, users require username and password, which needs to be unique.

Step 10 – Install the GRUB Boot Loader

- If windows is also installed on the same hard disk as Ubuntu, It will verify that GRUB boot loader is to be installed.
- The GRUB boot loader displays the list of operating systems installed on the computer when computer starts booting.

Step 11 – Reboot for the Second Installation Phase

Step 12 – Wait During Package Installation

Step 13 – Configure your Monitor

SHREE H. N. SHUKLA COLLEGE OF IT & MGMT.



(Affiliated to Saurashtra University & GTU)

2 - Vaishali Nagar
Nr. Amrapali Under Bridge
Raiya Road, Rajkot.
Ph.No–(0281)2440478

3 - Vaishali Nagar
Nr. Amrapali Under Bridge
Raiya Road, Rajkot.
Ph. No–(0281)2471645

- After package are installed, set the resolution for monitor

Step 14 – Boot for the first time

- After rebooting it display the Ubuntu login screen, where user can enter the password and enter the system.

One word question answer

Question

1. Which will be the first installation screen?
2. What is GRUB?

Answer

- language selection
Boot loader

Topic: 6 Explain startup, shutdown, and boot loader in Linux.

Ans.

Detail:

shutdown

- If you are going to initiate a shutdown of your system and there are other users logged in to your system, it is always polite to notify them first.
- To do this, we would use the **shutdown** command. The shutdown command will accept times and a broadcast message:

shutdown [options] time [warning_message]

- shutdown and reboot immediately

```
$ shutdown -r now
```

SHREE H. N. SHUKLA COLLEGE OF IT & MGMT.



(Affiliated to Saurashtra University & GTU)

2 - Vaishali Nagar
Nr. Amrapali Under Bridge
Raiya Road, Rajkot.
Ph.No–(0281)2440478

3 - Vaishali Nagar
Nr. Amrapali Under Bridge
Raiya Road, Rajkot.
Ph. No–(0281)2471645

Linux's boot process

- The Linux boot process is the name given to the startup procedures/order that your system goes through to load its operating system.
- In the following example, I will be referring to booting Linux on x86 architecture.

Boot Loader

- The Ubuntu installation routine writes a new boot sector (also known as boot loader).
- The boot loader is a separate program called GRUB (Grand Unified Boot Loader).
- If more than one operating system is installed, GRUB boot loader with list of all installed operating system appears.
- The first option will be selected automatically within 10 seconds.
- In the boot loader screen, all pre-installed operating systems are listed, apart from that an entry ending in “(recovery mode)”.
- This is a safe mode within windows, in that the system boots with safe system settings.

One word question answer

Question

1. Which command is used to shut down and reboot immediately? \$ shutdown -r now
2. GRUB stands for.

Answer

Grand Unified Boot Loader

SHREE H. N. SHUKLA COLLEGE OF IT & MGMT.



(Affiliated to Saurashtra University & GTU)

2 - Vaishali Nagar
Nr. Amrapali Under Bridge
Raiya Road, Rajkot.
Ph.No–(0281)2440478

3 - Vaishali Nagar
Nr. Amrapali Under Bridge
Raiya Road, Rajkot.
Ph. No–(0281)2471645

UNIT – 5 (Part-2)

Topic: 1 Explain Linux booting process.

Ans.

BIOS	Basic Input/Output System executes MBR
MBR	Master Boot Record executes GRUB
GRUB	Grand Unified Bootloader executes Kernel <small>thegeekstuff.com</small>
Kernel	Kernel executes /sbin/init
Init	Init executes runlevel programs
Runlevel	Runlevel programs are executed from /etc/rc.d/rc*.d/

Detail:

- The linux booting process is series of 6 stages which is also known as start-up sequence.
- The booting process is initiated and completed during the time you press the power button and until the login screen appears.

1. BIOS

- BIOS stands for Basic Input/Output System
- Performs some system integrity checks
- Searches, loads, and executes the boot loader program.

2. MBR

- MBR stands for Master Boot Record.
- It is located in the 1st sector of the bootable disk.
- MBR is less than 512 bytes in size.
- So, in simple terms MBR loads and executes the GRUB boot loader.

SHREE H. N. SHUKLA COLLEGE OF IT & MGMT.



(Affiliated to Saurashtra University & GTU)

2 - Vaishali Nagar
Nr. Amrapali Under Bridge
Raiya Road, Rajkot.
Ph.No–(0281)2440478

3 - Vaishali Nagar
Nr. Amrapali Under Bridge
Raiya Road, Rajkot.
Ph. No–(0281)2471645

3. GRUB

- GRUB stands for Grand Unified Bootloader.
- If you have multiple kernel images installed on your system, you can choose which one to be executed.

4. Kernel

- Mounts the root file system as specified in the “root=” in grub.conf
- Kernel executes the /sbin/init program

5. Init

- Looks at the /etc/inittab file to decide the Linux run level.
- Following are the available run levels
 - 0 – halt
 - 1 – Single user mode
 - 2 – Multiuser, without NFS
 - 3 – Full multiuser mode
 - 4 – unused
 - 5 – X11
 - 6 – reboot

6. Run level programs

- When the Linux system is booting up, you might see various services getting started.
- For example, it might say “starting send mail OK”.
- Those are the run level programs, executed from the run level directory as defined by your run level.

One word question answer

Question

1. How many stages of the Linux booting process?
2. BIOS stands for.
3. MBR stands for.

Answer

- 6
Basic Input/Output System
Master Boot Record

SHREE H. N. SHUKLA COLLEGE OF IT & MGMT.



(Affiliated to Saurashtra University & GTU)

2 - Vaishali Nagar
Nr. Amrapali Under Bridge
Raiya Road, Rajkot.
Ph.No-(0281)2440478

3 - Vaishali Nagar
Nr. Amrapali Under Bridge
Raiya Road, Rajkot.
Ph. No-(0281)2471645

Topic: 2 Explain LILO Configuration.

Ans.

Detail:

- LILO (Linux Loader) is a boot loader for Linux and was the default boot loader for most Linux distributions.
- Today, many distributions use GRUB as the default boot loader, but LILO is still in wide use.
- To work with LILO, the administrator needs to edit the file `/etc/lilo.conf` to set a default partition to boot, the time-out value, where LILO should be installed and other information.
- After that the administrator must update the loader by running the LILO command.

LILO Configuration File

- The following is a sample `/etc/lilo.conf`
boot=/dev/hda
map=/boot/map
install=/boot/boot.b
prompt
timeout=50
message=/boot/message
lba32
default=linux

One word question answer

Question

- 1.LILO stands for.
- 2.Which is lilo configuration file?

Answer

Linux Loader
lilo.conf

SHREE H. N. SHUKLA COLLEGE OF IT & MGMT.



(Affiliated to Saurashtra University & GTU)

2 - Vaishali Nagar
Nr. Amrapali Under Bridge
Raiya Road, Rajkot.
Ph.No–(0281)2440478

3 - Vaishali Nagar
Nr. Amrapali Under Bridge
Raiya Road, Rajkot.
Ph. No–(0281)2471645

Topic: 3 Explain GRUB Configuration.

Ans.

Detail:

- GRUB is a boot loader designed to boot a wide range of operating systems from a wide range of filesystems.
- GRUB is becoming popular due to the increasing number of possible root filesystems that Linux can reside upon.
- GRUB is documented in a GNU info file.
- The **GRUB** boot loader uses the configuration file `/boot/grub/grub.conf`.

GRUB Configuration File

```
default=0  
timeout=10  
splashimage=(hd0,0)/grub/splash.xpm.gz
```

- The ‘default =’ option tells GRUB which image to boot by default after the timeout period.
- The ‘splashimage’ option specifies the location of the image for use as the background for the GRUB GUI.

One word question answer

Question

1. GRUB is a _____.
2. Which is grub configuration file?

Answer

Boot Loader
grub.conf

SHREE H. N. SHUKLA COLLEGE OF IT & MGMT.



(Affiliated to Saurashtra University & GTU)

2 - Vaishali Nagar
Nr. Amrapali Under Bridge
Raiya Road, Rajkot.
Ph.No–(0281)2440478

3 - Vaishali Nagar
Nr. Amrapali Under Bridge
Raiya Road, Rajkot.
Ph. No–(0281)2471645

UNIT – 5(part - 3) Linux Admin (Ubuntu)

Topic: 1 Explain how to create Linux user account and password.

Ans.

Detail:

Creating Linux User Account and Password on Ubuntu

To create a new user in Ubuntu, use the adduser command. The following is the syntax to create.

sudo adduser newusername

- The sudo is a program for computer operating system such as UNIX, Linux that allows users to run programs with the security privileges of another user, by default the Superuser.
- The name is combination of “Do as Su” where “Su” is for “Super user”.

After typing that command following process started by Ubuntu:

- Type and confirm password.
 - Enter in the user’s information. This is optional. Press enter key to automatically fill the field with the default information.
 - Press Y (or Enter key) when asked to confirm the information.
- You have just added a new user to your Ubuntu operating system.

Deleting a User

- If any time you want to delete a specific user on the virtual private server, you can delete them with the following command:

sudo user del username

SHREE H. N. SHUKLA COLLEGE OF IT & MGMT.



(Affiliated to Saurashtra University & GTU)

2 - Vaishali Nagar
Nr. Amrapali Under Bridge
Raiya Road, Rajkot.
Ph.No–(0281)2440478

3 - Vaishali Nagar
Nr. Amrapali Under Bridge
Raiya Road, Rajkot.
Ph. No–(0281)2471645

- You should also delete the user's home directory. This can be done by following simple command :

```
sudo rm -rf /home/username
```

One word question answer

Question

To create a new user in Ubuntu which command is used?
newusername

Answer

Sudo adduser

The name 'sudo' is combination of _____

Do as Su

Topic: 2 Explain Samba server in detail.

Ans.

Detail:

- Samba is a software package, released in 1992, gives network administrators flexibility and freedom in terms of setup, configuration and choice of systems and equipment.
- Because of its ease and flexibility, Samba has become extremely popular and continues to do so.
- Samba runs on UNIX platforms, but can communicate to Windows clients just like the native platform.
- It allows a Unix system to move into a Windows Network without causing any mix-up.
- Windows users can easily access file and print services without having any problem.

Installing and Managing Samba Server

- If you want to share files between your Ubuntu and Windows computers, the best option is the Samba.
- Download latest version of samba from the site:
<https://www.samba.org/samba/ftp/samba-latest.tar.gz>
- To install, first open a terminal window and enter the following command:
sudo apt-get install samba smbfs

SHREE H. N. SHUKLA COLLEGE OF IT & MGMT.



(Affiliated to Saurashtra University & GTU)

2 - Vaishali Nagar
Nr. Amrapali Under Bridge
Raiya Road, Rajkot.
Ph.No-(0281)2440478

3 - Vaishali Nagar
Nr. Amrapali Under Bridge
Raiya Road, Rajkot.
Ph. No-(0281)2471645

- After the successful execution of this command, the Samba will get installed, now you must configure it to make it accessible.
- To configure it, open the configuration file using the following command in an editor:
sudo gedit /etc/samba/smb.conf

Find the following section in the file:

security = user

- Remove the comment before the security line and add the following line just below it:
security = user
username map = /etc/samba/smbusers
- This will set Samba to use the smbusers file for looking up the user list.

Creating Samba User

- There are two steps to creating a user.
- First we will run the smbpasswd utility to create a samba passwd for the user.

sudo smbpasswd -a <username>

- Next, we will add the username to the smbusers file.
sudo gedit /etc/samba/smbusers
- Add the following line, replacing the username with the one you want to give access to.
- The format is

<UbuntuUserName> = "<SambaUserName>".

SHREE H. N. SHUKLA COLLEGE OF IT & MGMT.



(Affiliated to Saurashtra University & GTU)

2 - Vaishali Nagar
Nr. Amrapali Under Bridge
Raiya Road, Rajkot.
Ph.No–(0281)2440478

3 - Vaishali Nagar
Nr. Amrapali Under Bridge
Raiya Road, Rajkot.
Ph. No–(0281)2471645

One word question answer

Question

Answer

- | | | |
|--|----------|---------|
| 1. To create a new user in Ubuntu which command is used?
newusername | sudo | adduser |
| 2. The name 'sudo' is combination of _____ | Do as Su | |
| 3. If you want to share files between your Ubuntu and
Windows computers, the best option is | Samba | |

Topic: 3 Explain Apache server in detail.

Ans.

Detail:

- The Apache Web Server is one of the most popular open-source HTTP servers.
- It is powerful, secure, and fully featured web server.

Installing Apache HTTP Web Server

- First, you should have the Apache server downloaded or download the Apache Server for Linux.
- Now extract the Apache Files by following commands:

```
gunzip -d httpd-2_0_NN.tar.gz  
tar xvf httpd-2_0_NN.tar
```

- To install Apache server on Ubuntu, use following commands:

```
sudo apt-get update  
sudo apt-get install apache2
```

- The Apache server is installed.
- To check if Apache is installed, go to your browser, enter your server's IP address.

SHREE H. N. SHUKLA COLLEGE OF IT & MGMT.



(Affiliated to Saurashtra University & GTU)

2 - Vaishali Nagar
Nr. Amrapali Under Bridge
Raiya Road, Rajkot.
Ph.No–(0281)2440478

3 - Vaishali Nagar
Nr. Amrapali Under Bridge
Raiya Road, Rajkot.
Ph. No–(0281)2471645

- The page should display the message: “It Works!”

Managing Apache Server

- You must understand the main configuration files of Apache which can be found in the “/etc/apache2” folder.
- You can explore this folder by following command:

```
cd /etc/apache2
```

```
ls
```

you will see file listing. Following configuration files are necessary to understand:

apache2.conf : This is the main configuration file for the server. You can do almost all configurations within this file.

ports.conf : You can specify the ports from where virtual hosts can listen.

conf.d/ (Directory) : This directory is used for controlling specific features of the Apache configuration. For example, It is frequently used to define SSL configuration.

sites-available/ (Directory) : This directory contains all of the virtual hosts files that define different web sites.

sites-enabled/ (Directory) : This directory defines which virtual host definitions are actually being used.

mods-[enabled,available]/ (Directory) : These directories are similar in function to sites directories, but they define modules that can be loaded optionally.

One word question answer

Question

Answer

1. To install Apache server on Ubuntu which command is used? `sudo apt-get install apache2`
2. Where can we find the main configuration files of apache? `“/etc/apache2”` folder
3. The main configuration file for the apache server is _____. `apache2.conf`

SHREE H. N. SHUKLA COLLEGE OF IT & MGMT.



(Affiliated to Saurashtra University & GTU)

2 - Vaishali Nagar
Nr. Amrapali Under Bridge
Raiya Road, Rajkot.
Ph.No–(0281)2440478

3 - Vaishali Nagar
Nr. Amrapali Under Bridge
Raiya Road, Rajkot.
Ph. No–(0281)2471645

Topic: 4 Explain how to optimize LDAP Services.

Ans.

Detail:

Optimizing LDAP Services

- LDAP (Lightweight Directory Access Protocol) is a protocol for managing information from a centralized location over the use of a file and directory hierarchy.
- It can be used to organize and store any kind of information.
- LDAP is mainly used for centralized authentication.

Install LDAP

- The OpenLDAP server is in Ubuntu's default package "slapd", so we can install it easily with apt-get.
- We will also install some additional utilities.

```
sudo apt-get update
```

```
sudo apt-get install slapdldap-utils
```

You must enter administrator password for the admin LDAP account.

Reconfigure slapd

- When the installation is complete, we need to reconfigure the LDAP package. Type the following to reconfigure:

```
sudo dpkg-reconfigure slapd
```

You must answer some questions about the configuration such as:

OpenLDAP Server configuration? Reply No.

DNS Domain Name? test.com

And so on...

SHREE H. N. SHUKLA COLLEGE OF IT & MGMT.



(Affiliated to Saurashtra University & GTU)

2 - Vaishali Nagar
Nr. Amrapali Under Bridge
Raiya Road, Rajkot.
Ph.No-(0281)2440478

3 - Vaishali Nagar
Nr. Amrapali Under Bridge
Raiya Road, Rajkot.
Ph. No-(0281)2471645

One word question answer

Question

1. LDAP stands for.
Protocol

2. Which command is used to install LDAP package?
slapdldap-utils

3. Command to reconfigure the LDAP package.

Answer

Lightweight Directory Access

sudo apt-get install

sudo dpkg-reconfigure slapd

Topic: 5 Explain DNS optimizing.

Ans.

Detail:

- We can also optimize DNS (Domain Name System) services on Linux (Ubuntu).
- The DNS is, as the name suggests, a simple naming system for your server so that you can remember the address by its name rather than its IP address.

One word question answer

Question

1. DNS stands for.

Answer

Domain Name System

Topic: 6 Explain FTP optimizing.

Ans.

Detail:

- FTP servers are a common way of sharing files between individuals with or without authentication.
- FTP is superior to HTTP (web) if the goal is to transfer files, not display information.

SHREE H. N. SHUKLA COLLEGE OF IT & MGMT.



(Affiliated to Saurashtra University & GTU)

2 - Vaishali Nagar
Nr. Amrapali Under Bridge
Raiya Road, Rajkot.
Ph.No–(0281)2440478

3 - Vaishali Nagar
Nr. Amrapali Under Bridge
Raiya Road, Rajkot.
Ph. No–(0281)2471645

- After successful setup of an FTP server, you may need to optimize its services to get the better performance every time.
- For this, you need its proper configuration.
- FTP is file transfer protocol; security must be for safe file transfer.

One word question answer

Question

1. FTP stands for.

Answer

File Transfer Protocol

Topic: 7 Explain how to optimize web services.

Ans.

Detail:

- Apache is a powerful and capable web server.
- To make initial setup as easy as possible, this makes it a great choice for new projects when you need to be productive quickly.
- Here are the few steps to optimize the web service performance of Apache Web Server.

1. Unload Unneeded Modules

- In Ubuntu based system, you will see a folder called /etc/apache2/mods-enabled and /etc/apache2/mods-available/.
- The mods-available folder is a list of all the modules installed on a particular server.
- You should disable following modules if you do not need them:

PHP

SSL

Rewrite

Perl

Python

Rack / Ruby / Passenger

SHREE H. N. SHUKLA COLLEGE OF IT & MGMT.



(Affiliated to Saurashtra University & GTU)

2 - Vaishali Nagar
Nr. Amrapali Under Bridge
Raiya Road, Rajkot.
Ph.No–(0281)2440478

3 - Vaishali Nagar
Nr. Amrapali Under Bridge
Raiya Road, Rajkot.
Ph. No–(0281)2471645

2. Limit the Number of Apache Processes.

One word question answer

Question

1. From where we can Unload Unneeded Modules?
2. Steps to optimize web service_____

Answer

/etc/apache2/mods-enabled
Unload Unneeded Modules,
Limit the Number of Processes

Topic: 8 Explain how to configure firewall in ubuntu.

Ans.

Detail:

- Firewall is considered as the first method of defense in securing your cloud server.
- Ubuntu includes its own (built-in) Firewall known as UFW.
- UFW stands for “Uncomplicated Firewall”.
- Its main goal is to provide an easy-to use interface.
- The firewall is disabled by default. To enable the firewall, run the following commands from a terminal.

sudo ufw enable

- To install Firewall:

sudo aptitude install ufw

Or

sudo apt-get install ufw

- To check the status, use following command:

sudo ufw status

Setup rules

SHREE H. N. SHUKLA COLLEGE OF IT & MGMT.



(Affiliated to Saurashtra University & GTU)

2 - Vaishali Nagar
Nr. Amrapali Under Bridge
Raiya Road, Rajkot.
Ph.No–(0281)2440478

3 - Vaishali Nagar
Nr. Amrapali Under Bridge
Raiya Road, Rajkot.
Ph. No–(0281)2471645

- You should first define some rules for the firewall for allowing and denying connection.
- To set the defaults used by UFW, use the following commands
sudo ufw default deny incoming
And
sudo ufw default allow outgoing
- If you want to deny the outgoing request also, use the following command:
sudo ufw default deny outgoing
- Enable the SSH connection, use this command:
sudo ufw allow ssh

Deleting rules

- There are two option to delete rules.

sudo ufw delete allow ssh

- If you need to reset your cloud server's rules to their default settings, you can do this :
sudo ufw reset

One word question answer

Question

1. What is UFW?
2. Which command is used to enable the firewall?
3. How to enable the SSH connection?

Answer

Uncomplicated Firewall
sudo ufw enable
sudo ufw allow ssh

Topic: 9 Explain WINE.

Ans.

Detail:

- As we know that Linux is a great operating system, If you like a Window game or other app, you need to use Wine to run it right on your Ubuntu desktop.

SHREE H. N. SHUKLA COLLEGE OF IT & MGMT.



(Affiliated to Saurashtra University & GTU)

2 - Vaishali Nagar
Nr. Amrapali Under Bridge
Raiya Road, Rajkot.
Ph.No–(0281)2440478

3 - Vaishali Nagar
Nr. Amrapali Under Bridge
Raiya Road, Rajkot.
Ph. No–(0281)2471645

Installing Wine

- You will find the Wine download in the Ubuntu Software Center in all version.
- Download and install it.

Running an Application

- After successful installation of Wine, you can download an application's EXE file to install it by simply double-clicking it.
- You can also use terminal to install an application
- Use following command:

wine /path/to/application.exe

- After installation of the application, you can find it's shortcut icon on Desktop as we find it on Windows OS.

One word question answer

Question

1. Wine is used for.

Answer

Window game or other app